

CONSTRUCTION CONTRACT

G STREET RAILING REPAIR – PROJECT NO. CP230066

1. Parties and Date.

This Contract is made and entered into this _____ day of _____, _____ by and between the City of Merced, a public agency of the State of California (“City”) and American Paving Co., a California Corporation with its principal place of business at 525 W. Alluvial Ave, Fresno, CA 93711 (“Contractor”). City and Contractor are sometimes individually referred to as “Party” and collectively as “Parties” in this Contract.

2. Recitals.

2.1 City. City is a public agency organized under the laws of the State of California, with power to contract for services necessary to achieve its purpose.

2.2 Contractor. Contractor desires to perform and assume responsibility for the provision of certain construction services required by the City on the terms and conditions set forth in this Contract. Contractor represents that it is duly licensed and experienced in providing services such as the reconstruction of approximately 30 lineal feet of metal bridge railing and electrical conduit along the north side of Bear Creek Bridge crossing over Bear Creek.. The following license classifications are required for this Project: **Class “A”**

2.3 Project. City desires to engage Contractor to render such services for the G STREET RAILING REPAIR – Project No. CP230066 as set forth in this Contract.

2.4 Project Documents & Certifications. Contractor has obtained, and delivers concurrently herewith, a performance bond, a payment bond, and all insurance documentation, as required by the Contract.

3. Terms

3.1 Incorporation of Documents. This Contract includes and hereby incorporates in full by reference the following documents, including all exhibits, drawings, specifications and documents therein, and attachments and addenda thereto:

- Services/Schedule (Exhibit “A”)
- Plans and Specifications (Exhibit “B”)
- Special Conditions (Exhibit “C”)
- Contractor’s Certificate Regarding Workers’ Compensation (Exhibit “D”)
- Public Works Contractor Registration Certification (Exhibit “E”)
- Payment and Performance Bonds (Exhibit “F”)
- Addenda
- Change Orders executed by the City

- Latest Edition of the Standard Specifications for Public Works Construction (Green Book), Excluding Sections 1-9
- Notice Inviting Bids, if any
- Instructions to Bidders, if any
- Contractor's Bid

3.2 Contractor's Basic Obligation; Scope of Work. Contractor promises and agrees, at its own cost and expense, to furnish to the City all labor, materials, tools, equipment, services, and incidental and customary work necessary to fully and adequately complete the Project, including all structures and facilities necessary for the Project or described in the Contract (hereinafter sometimes referred to as the "Work"), for a Total Contract Price as specified pursuant to this Contract. All Work shall be subject to, and performed in accordance with the above referenced documents, as well as the exhibits attached hereto and incorporated herein by reference. The plans and specifications for the Work are further described in Exhibit "B" attached hereto and incorporated herein by this reference. Special Conditions, if any, relating to the Work are described in Exhibit "C" attached hereto and incorporated herein by this reference.

3.2.1 Change in Scope of Work. Any change in the scope of the Work, method of performance, nature of materials or price thereof, or any other matter materially affecting the performance or nature of the Work shall not be paid for or accepted unless such change, addition or deletion is approved in writing by a valid change order executed by the City. Should Contractor request a change order due to unforeseen circumstances affecting the performance of the Work, such request shall be made within five (5) business days of the date such circumstances are discovered or shall waive its right to request a change order due to such circumstances. If the Parties cannot agree on any change in price required by such change in the Work, the City may direct the Contractor to proceed with the performance of the change on a time and materials basis.

3.2.2 Substitutions/"Or Equal". Pursuant to Public Contract Code Section 3400(b), the City may make a finding that designates certain products, things, or services by specific brand or trade name. Unless specifically designated in this Contract, whenever any material, process, or article is indicated or specified by grade, patent, or proprietary name or by name of manufacturer, such Specifications shall be deemed to be used for the purpose of facilitating the description of the material, process or article desired and shall be deemed to be followed by the words "or equal."

Contractor may, unless otherwise stated, offer for substitution any material, process or article which shall be substantially equal or better in every respect to that so indicated or specified in this Contract. However, the City may have adopted certain uniform standards for certain materials, processes and articles. Contractor shall submit requests, together with substantiating data, for substitution of any "or equal" material, process or article no later than thirty-five (35) days after award of the Contract. To facilitate the construction schedule and sequencing, some requests may need to be submitted before thirty-five (35) days after award of Contract. Provisions regarding submission of "or equal" requests shall not in any way authorize an extension of time for performance of this Contract. If a proposed "or equal" substitution request is rejected, Contractor shall be responsible for providing the specified material, process or article. The burden of proof as to the equality of any material, process or article shall rest with Contractor.

The City has the complete and sole discretion to determine if a material, process or article is an "or equal" material, process or article that may be substituted. Data required to substantiate requests for substitutions of an "or equal" material, process or article data shall include a signed affidavit from Contractor stating that, and describing how, the substituted "or equal"

material, process or article is equivalent to that specified in every way except as listed on the affidavit. Substantiating data shall include any and all illustrations, specifications, and other relevant data including catalog information which describes the requested substituted "or equal" material, process or article, and substantiates that it is an "or equal" to the material, process or article. The substantiating data must also include information regarding the durability and lifecycle cost of the requested substituted "or equal" material, process or article. Failure to submit all the required substantiating data, including the signed affidavit, to the City in a timely fashion will result in the rejection of the proposed substitution.

Contractor shall bear all of the City's costs associated with the review of substitution requests. Contractor shall be responsible for all costs related to a substituted "or equal" material, process or article. Contractor is directed to the Special Conditions (if any) to review any findings made pursuant to Public Contract Code section 3400.

3.3 Period of Performance and Liquidated Damages. Contractor shall perform and complete all Work under this Contract within **45 working days**, beginning the effective date of the Notice to Proceed ("Contract Time"). Contractor shall perform its Work in strict accordance with any completion schedule, construction schedule or project milestones developed by the City. Such schedules or milestones may be included as part of Exhibits "A" or "B" attached hereto or may be provided separately in writing to Contractor. Contractor agrees that if such Work is not completed within the aforementioned Contract Time and/or pursuant to any such completion schedule, construction schedule or project milestones developed pursuant to provisions of the Contract, it is understood, acknowledged and agreed that the City will suffer damage. Pursuant to Government Code Section 53069.85, Contractor shall pay to the City as fixed and liquidated damages the sum of **\$3,600 per day** for each and every calendar day of delay beyond the Contract Time or beyond any completion schedule, construction schedule or Project milestones established pursuant to the Contract.

3.4 Standard of Performance; Performance of Employees. Contractor shall perform all Work under this Contract in a skillful and workmanlike manner, and consistent with the standards generally recognized as being employed by professionals in the same discipline in the State of California. Contractor represents and maintains that it is skilled in the professional calling necessary to perform the Work. Contractor warrants that all employees and subcontractors shall have sufficient skill and experience to perform the Work assigned to them. Finally, Contractor represents that it, its employees and subcontractors have all licenses, permits, qualifications and approvals of whatever nature that are legally required to perform the Work, including any required business license, and that such licenses and approvals shall be maintained throughout the term of this Contract. As provided for in the indemnification provisions of this Contract, Contractor shall perform, at its own cost and expense and without reimbursement from the City, any work necessary to correct errors or omissions which are caused by Contractor's failure to comply with the standard of care provided for herein. Any employee who is determined by the City to be uncooperative, incompetent, a threat to the safety of persons or the Work, or any employee who fails or refuses to perform the Work in a manner acceptable to the City, shall be promptly removed from the Project by Contractor and shall not be re-employed on the Work.

3.5 Control and Payment of Subordinates; Contractual Relationship. City retains Contractor on an independent contractor basis and Contractor is not an employee of City. Any additional personnel performing the work governed by this Contract on behalf of Contractor shall at all times be under Contractor's exclusive direction and control. Contractor shall pay all wages, salaries, and other amounts due such personnel in connection with their performance under this Contract and as required by law. Contractor shall be responsible for all reports and obligations

respecting such additional personnel, including, but not limited to: social security taxes, income tax withholding, unemployment insurance, and workers' compensation insurance.

3.6 City's Basic Obligation. City agrees to engage and does hereby engage Contractor as an independent contractor to furnish all materials and to perform all Work according to the terms and conditions herein contained for the sum set forth above. Except as otherwise provided in the Contract, the City shall pay to Contractor, as full consideration for the satisfactory performance by Contractor of the services and obligations required by this Contract, the below-referenced compensation in accordance with compensation provisions set forth in the Contract.

3.7 Compensation and Payment.

3.7.1 Amount of Compensation. As consideration for performance of the Work required herein, City agrees to pay Contractor the Total Contract Price of One hundred forty-eight thousand four hundred Dollars (\$148,400.00) ("Total Contract Price") provided that such amount shall be subject to adjustment pursuant to the applicable terms of this Contract or written change orders approved and signed in advance by the City.

3.7.2 Payment of Compensation. If the Work is scheduled for completion in thirty (30) or less calendar days, City will arrange for payment of the Total Contract Price upon completion and approval by City of the Work. If the Work is scheduled for completion in more than thirty (30) calendar days, City will pay Contractor on a monthly basis as provided for herein. On or before the fifth (5th) day of each month, Contractor shall submit to the City an itemized application for payment in the format supplied by the City indicating the amount of Work completed since commencement of the Work or since the last progress payment. These applications shall be supported by evidence which is required by this Contract and such other documentation as the City may require. The Contractor shall certify that the Work for which payment is requested has been done and that the materials listed are stored where indicated. Contractor may be required to furnish a detailed schedule of values upon request of the City and in such detail and form as the City shall request, showing the quantities, unit prices, overhead, profit, and all other expenses involved in order to provide a basis for determining the amount of progress payments.

3.7.3 Prompt Payment. City shall review and pay all progress payment requests in accordance with the provisions set forth in Section 20104.50 of the California Public Contract Code. However, no progress payments will be made for Work not completed in accordance with this Contract. Contractor shall comply with all applicable laws, rules and regulations relating to the proper payment of its employees, subcontractors, suppliers, or others.

3.7.4 Contract Retentions. From each approved progress estimate, five percent (5%) will be deducted and retained by the City, and the remainder will be paid to Contractor. All Contract retention shall be released and paid to Contractor and subcontractors pursuant to California Public Contract Code Section 7107.

3.7.5 Other Retentions. In addition to Contract retentions, the City may deduct from each progress payment an amount necessary to protect City from loss because of: (1) liquidated damages which have accrued as of the date of the application for payment; (2) any sums expended by the City in performing any of Contractor's obligations under the Contract which Contractor has failed to perform or has performed inadequately; (3) defective Work not remedied; (4) stop notices as allowed by state law; (5) reasonable doubt that the Work can be completed for the unpaid balance of the Total Contract Price or within the scheduled completion date; (6) unsatisfactory prosecution of the Work by Contractor; (7) unauthorized deviations from the Contract;

(8) failure of Contractor to maintain or submit on a timely basis proper and sufficient documentation as required by the Contract or by City during the prosecution of the Work; (9) erroneous or false estimates by Contractor of the value of the Work performed; (10) any sums representing expenses, losses, or damages as determined by the City, incurred by the City for which Contractor is liable under the Contract; and (11) any other sums which the City is entitled to recover from Contractor under the terms of the Contract or pursuant to state law, including Section 1727 of the California Labor Code. The failure by the City to deduct any of these sums from a progress payment shall not constitute a waiver of the City's right to such sums.

3.7.6 Substitutions for Contract Retentions. In accordance with California Public Contract Code Section 22300, the City will permit the substitution of securities for any monies withheld by the City to ensure performance under the Contract. At the request and expense of Contractor, securities equivalent to the amount withheld shall be deposited with the City, or with a state or federally chartered bank in California as the escrow agent, and thereafter the City shall then pay such monies to Contractor as they come due. Upon satisfactory completion of the Contract, the securities shall be returned to Contractor. For purposes of this Section and Section 22300 of the Public Contract Code, the term "satisfactory completion of the contract" shall mean the time the City has issued written final acceptance of the Work and filed a Notice of Completion as required by law and provisions of this Contract. Contractor shall be the beneficial owner of any securities substituted for monies withheld and shall receive any interest thereon. The escrow agreement used for the purposes of this Section shall be in the form provided by the City.

3.7.7 Title to Work. As security for partial, progress, or other payments, title to Work for which such payments are made shall pass to the City at the time of payment. To the extent that title has not previously been vested in the City by reason of payments, full title shall pass to the City at delivery of the Work at the destination and time specified in this Contract. Such transferred title shall in each case be good, free and clear from any and all security interests, liens, or other encumbrances. Contractor promises and agrees that it will not pledge, hypothecate, or otherwise encumber the items in any manner that would result in any lien, security interest, charge, or claim upon or against said items. Such transfer of title shall not imply acceptance by the City, nor relieve Contractor from the responsibility to strictly comply with the Contract and shall not relieve Contractor of responsibility for any loss of or damage to items.

3.7.8 Labor and Material Releases. Contractor shall furnish City with labor and material releases from all subcontractors performing work on, or furnishing materials for, the Work governed by this Contract prior to final payment by City.

3.7.9 Prevailing Wages. Contractor is aware of the requirements of California Labor Code Section 1720 et seq., and 1770 et seq., as well as California Code of Regulations, Title 8, Section 16000 et seq., ("Prevailing Wage Laws"), which require the payment of prevailing wage rates and the performance of other requirements on "public works" and "maintenance" projects. Since the Services are being performed as part of an applicable "public works" or "maintenance" project, as defined by the Prevailing Wage Laws, and since the total compensation is \$1,000 or more, Contractor agrees to fully comply with such Prevailing Wage Laws. City shall provide Contractor with a copy of the prevailing rates of per diem wages in effect at the commencement of this Contract upon request. Contractor shall make copies of the prevailing rates of per diem wages for each craft, classification or type of worker needed to execute the Services available to interested parties upon request and shall post copies at Contractor's principal place of business and at the project site. Contractor shall defend, indemnify and hold the City, its officials, officers, employees and agents free and harmless from any claim or liability arising out of any failure or alleged failure to comply with the Prevailing Wage Laws. Contractor and any subcontractor shall forfeit a penalty

of up to \$200 per calendar day or portion thereof for each worker paid less than the prevailing wage rates.

3.7.10 Apprenticeable Crafts. When Contractor employs workmen in an apprenticeable craft or trade, Contractor shall comply with the provisions of Section 1777.5 of the California Labor Code with respect to the employment of properly registered apprentices upon public works. The primary responsibility for compliance with said section for all apprenticeable occupations shall be with Contractor. The Contractor or any subcontractor that is determined by the Labor Commissioner to have knowingly violated Section 1777.5 shall forfeit as a civil penalty an amount not exceeding \$100 for each full calendar day of noncompliance, or such greater amount as provided by law.

3.7.11 Hours of Work. Contractor is advised that eight (8) hours labor constitutes a legal day's work. Pursuant to Section 1813 of the California Labor Code, Contractor shall forfeit a penalty of \$25.00 per worker for each day that each worker is permitted to work more than eight (8) hours in any one calendar day and forty (40) hours in any one calendar week, except when payment for overtime is made at not less than one and one-half (1-1/2) times the basic rate for that worker.

3.7.12 Payroll Records. Contractor and each subcontractor shall keep an accurate payroll record, showing the name, address, social security number, work classification, straight time and overtime hours worked each day and week, and the actual per diem wages paid to each journeyman, apprentice, worker, or other employee employed by him or her in connection with the public work. The payroll records shall be certified and shall be available for inspection at all reasonable hours at the principal office of Contractor in the manner provided in Labor Code section 1776. In the event of noncompliance with the requirements of this section, Contractor shall have 10 days in which to comply subsequent to receipt of written notice specifying in what respects such Contractor must comply with this section. Should noncompliance still be evident after such 10-day period, Contractor shall, as a penalty to City, forfeit not more than \$100.00 for each calendar day or portion thereof, for each worker, until strict compliance is effectuated. The amount of the forfeiture is to be determined by the Labor Commissioner. A contractor who is found to have violated the provisions of law regarding wages on Public Works with the intent to defraud shall be ineligible to bid on Public Works contracts for a period of one to three years as determined by the Labor Commissioner. Upon the request of the Division of Apprenticeship Standards or the Division of Labor Standards Enforcement, such penalties shall be withheld from progress payments then due. The responsibility for compliance with this section is on Contractor. The requirement to submit certified payroll records directly to the Labor Commissioner under Labor Code section 1771.4 shall not apply to work performed on a public works project that is exempt pursuant to the small project exemption specified in Labor Code Section 1771.4.

3.7.13 Contractor and Subcontractor Registration. Pursuant to Labor Code sections 1725.5 and 1771.1, all contractors and subcontractors that wish to bid on, be listed in a bid proposal, or enter into a contract to perform public work must be registered with the Department of Industrial Relations. No bid will be accepted nor any contract entered into without proof of the contractor's and subcontractors' current registration with the Department of Industrial Relations to perform public work. Contractor is directed to review, fill out and execute the Public Works

Contractor Registration Certification attached hereto as Exhibit "E" prior to contract execution. Notwithstanding the foregoing, the contractor registration requirements mandated by Labor Code Sections 1725.5 and 1771.1 shall not apply to work performed on a public works project that is exempt pursuant to the small project exemption specified in Labor Code Sections 1725.5 and 1771.1.

3.7.14 Labor Compliance; Stop Orders. This Project is subject to compliance monitoring and enforcement by the Department of Industrial Relations. It shall be the Contractor's sole responsibility to evaluate and pay the cost of complying with all labor compliance requirements under this Contract and applicable law. Any stop orders issued by the Department of Industrial Relations against Contractor or any subcontractor that affect Contractor's performance of Work, including any delay, shall be Contractor's sole responsibility. Any delay arising out of or resulting from such stop orders shall be considered Contractor caused delay subject to any applicable liquidated damages and shall not be compensable by the City. Contractor shall defend, indemnify and hold the City, its officials, officers, employees and agents free and harmless from any claim or liability arising out of stop orders issued by the Department of Industrial Relations against Contractor or any subcontractor.

3.8 Performance of Work; Jobsite Obligations.

3.8.1 Water Quality Management and Compliance.

3.8.1.1 Water Quality Management and Compliance. Contractor shall keep itself and all subcontractors, staff, and employees fully informed of and in compliance with all local, state and federal laws, rules and regulations that may impact, or be implicated by the performance of the Work including, without limitation, all applicable provisions of the Federal Water Pollution Control Act (33 U.S.C. §§ 1300); the California Porter-Cologne Water Quality Control Act (Cal Water Code §§ 13000-14950); local ordinances regulating discharges of storm water; and any and all regulations, policies, or permits issued pursuant to any such authority regulating the discharge of pollutants, as that term is used in the Porter-Cologne Water Quality Control Act, to any ground or surface water in the State.

3.8.1.2 Compliance with the Statewide Construction General Permit. Contractor shall comply with all conditions of the most recent iteration of the National Pollutant Discharge Elimination System General Permit for Storm Water Discharges Associated with Construction Activity, issued by the California State Water Resources Control Board ("Permit"). It shall be Contractor's sole responsibility to file a Notice of Intent and procure coverage under the Permit for all construction activity which results in the disturbance of more than one acre of total land area or which is part of a larger common area of development or sale. Prior to initiating work, Contractor shall be solely responsible for preparing and implementing a Storm Water Pollution Prevention Plan (SWPPP) as required by the Permit. Contractor shall be responsible for procuring, implementing and complying with the provisions of the Permit and the SWPPP, including the standard provisions, and monitoring and reporting requirements as required by the Permit. The Permit requires the SWPPP to be a "living document" that changes as necessary to meet the conditions and requirements of the job site as it progresses through difference phases of construction and is subject to different weather conditions. It shall be Contractor's sole responsibility to update the SWPPP as necessary to address conditions at the project site.

3.8.1.3 Other Water Quality Rules Regulations and Policies. Contractor shall comply with the lawful requirements of any applicable municipality, drainage City,

or local agency regarding discharges of storm water to separate storm drain systems or other watercourses under their jurisdiction, including applicable requirements in municipal storm water management programs.

3.8.1.4 Cost of Compliance. Storm, surface, nuisance, or other waters may be encountered at various times during construction of The Work. Therefore, the Contractor, by submitting a Bid, hereby acknowledges that it has investigated the risk arising from such waters, has prepared its Bid accordingly, and assumes any and all risks and liabilities arising therefrom.

3.8.1.5 Liability for Non-Compliance. Failure to comply with the Permit is a violation of federal and state law. Pursuant to the indemnification provisions of this Contract, Contractor hereby agrees to defend, indemnify and hold harmless the City and its officials, officers, employees, volunteers and agents for any alleged violations. In addition, City may seek damages from Contractor for any delay in completing the Work in accordance with the Contract, if such delay is caused by or related to Contractor's failure to comply with the Permit.

3.8.1.6 Reservation of Right to Defend. City reserves the right to defend any enforcement action brought against the City for Contractor's failure to comply with the Permit or any other relevant water quality law, regulation, or policy. Pursuant to the indemnification provisions of this Contract, Contractor hereby agrees to be bound by, and to reimburse the City for the costs (including the City's attorney's fees) associated with, any settlement reached between the City and the relevant enforcement entity.

3.8.1.7 Training. In addition to the standard of performance requirements set forth in paragraph 3.4, Contractor warrants that all employees and subcontractors shall have sufficient skill and experience to perform the Work assigned to them without impacting water quality in violation of the laws, regulations and policies described in paragraph 3.8.1. Contractor further warrants that it, its employees and subcontractors will receive adequate training, as determined by City, regarding the requirements of the laws, regulations and policies described in paragraph 3.8.1 as they may relate to the Work provided under this Agreement. Upon request, City will provide the Contractor with a list of training programs that meet the requirements of this paragraph.

3.8.2 Safety. Contractor shall execute and maintain its work so as to avoid injury or damage to any person or property. Contractor shall comply with the requirements of the specifications relating to safety measures applicable in particular operations or kinds of work. In carrying out its Work, Contractor shall at all times be in compliance with all applicable local, state and federal laws, rules and regulations, and shall exercise all necessary precautions for the safety of employees appropriate to the nature of the Work and the conditions under which the Work is to be performed. Safety precautions as applicable shall include, but shall not be limited to, adequate life protection and lifesaving equipment; adequate illumination for underground and night operations; instructions in accident prevention for all employees, such as machinery guards, safe walkways, scaffolds, ladders, bridges, gang planks, confined space procedures, trenching and shoring, fall protection and other safety devices, equipment and wearing apparel as are necessary or lawfully required to prevent accidents or injuries; and adequate facilities for the proper inspection and maintenance of all safety measures. Furthermore, Contractor shall prominently display the names and telephone numbers of at least two medical doctors practicing in the vicinity of the Project, as well as the telephone number of the local ambulance service, adjacent to all telephones at the Project site.

3.8.3 Laws and Regulations. Contractor shall keep itself fully informed of and in compliance with all local, state and federal laws, rules and regulations in any manner affecting the performance of the Contract or the Work, including all Cal/OSHA requirements, and shall give all notices required by law. Contractor shall be liable for all violations of such laws and regulations in connection with Work. If Contractor observes that the drawings or specifications are at variance with any law, rule or regulation, it shall promptly notify the City in writing. Any necessary changes shall be made by written change order. If Contractor performs any work knowing it to be contrary to such laws, rules and regulations and without giving written notice to the City, Contractor shall be solely responsible for all costs arising therefrom. City is a public entity of the State of California subject to certain provisions of the Health & Safety Code, Government Code, Public Contract Code, and Labor Code of the State. It is stipulated and agreed that all provisions of the law applicable to the public contracts of a municipality are a part of this Contract to the same extent as though set forth herein and will be complied with. Contractor shall defend, indemnify and hold City, its officials, officers, employees and agents free and harmless, pursuant to the indemnification provisions of this Contract, from any claim or liability arising out of any failure or alleged failure to comply with such laws, rules or regulations.

3.8.4 Permits and Licenses. Contractor shall be responsible for securing City permits and licenses necessary to perform the Work described herein, including, but not limited to, any required business license. While Contractor will not be charged a fee for any City permits, Contractor shall pay the City's business license fee, if any. Any ineligible contractor or subcontractor pursuant to Labor Code Sections 1777.1 and 1777.7 may not perform work on this Project.

3.8.5 Trenching Work. If the Total Contract Price exceeds \$25,000 and if the Work governed by this Contract entails excavation of any trench or trenches five (5) feet or more in depth, Contractor shall comply with all applicable provisions of the California Labor Code, including Section 6705. To this end, Contractor shall submit for City's review and approval a detailed plan showing the design of shoring, bracing, sloping, or other provisions to be made for worker protection from the hazard of caving ground during the excavation of such trench or trenches. If such plan varies from the shoring system standards, the plan shall be prepared by a registered civil or structural engineer.

3.8.6 Hazardous Materials and Differing Conditions. As required by California Public Contract Code Section 7104, if this Contract involves digging trenches or other excavations that extend deeper than four (4) feet below the surface, Contractor shall promptly, and prior to disturbance of any conditions, notify City of: (1) any material discovered in excavation that Contractor believes to be a hazardous waste that is required to be removed to a Class I, Class II or Class III disposal site; (2) subsurface or latent physical conditions at the site differing from those indicated by City; and (3) unknown physical conditions of an unusual nature at the site, significantly different from those ordinarily encountered in such contract work. Upon notification, City shall promptly investigate the conditions to determine whether a change order is appropriate. In the event of a dispute, Contractor shall not be excused from any scheduled completion date and shall proceed with all Work to be performed under the Contract, but shall retain all rights provided by the Contract or by law for making protests and resolving the dispute.

3.8.7 Underground Utility Facilities. To the extent required by Section 4215 of the California Government Code, City shall compensate Contractor for the costs of: (1) locating and repairing damage to underground utility facilities not caused by the failure of Contractor to exercise reasonable care; (2) removing or relocating underground utility facilities not indicated in the construction drawings; and (3) equipment necessarily idled during such work. Contractor shall not

be assessed liquidated damages for delay caused by failure of City to provide for removal or relocation of such utility facilities.

3.8.8 Air Quality. Contractor must fully comply with all applicable laws, rules and regulations in furnishing or using equipment and/or providing services, including, but not limited to, emissions limits and permitting requirements imposed by the California Air Resources Board (CARB). Although CARB limits and requirements are more broad, Contractor shall specifically be aware of their application to "portable equipment", which definition is considered by CARB to include any item of equipment with a fuel-powered engine. Contractor shall indemnify City against any fines or penalties imposed by CARB, or any other governmental or regulatory agency for violations of applicable laws, rules and/or regulations by Contractor, its subcontractors, or others for whom Contractor is responsible under its indemnity obligations provided for in this Agreement.

3.8.9 State Recycling Mandates. Contractor shall comply with State Recycling Mandates. Any recyclable materials/debris collected by the contractor that can be feasibly diverted via reuse or recycling must be hauled by the appropriate handler for reuse or recycling.

3.9 Completion of Work. When Contractor determines that it has completed the Work required herein, Contractor shall so notify City in writing and shall furnish all labor and material releases required by this Contract. City shall thereupon inspect the Work. If the Work is not acceptable to the City, the City shall indicate to Contractor in writing the specific portions or items of Work which are unsatisfactory or incomplete. Once Contractor determines that it has completed the incomplete or unsatisfactory Work, Contractor may request a reinspection by the City. Once the Work is acceptable to City, City shall pay to Contractor the Total Contract Price remaining to be paid, less any amount which City may be authorized or directed by law to retain. Payment of retention proceeds due to Contractor shall be made in accordance with Section 7107 of the California Public Contract Code.

3.10 Claims; Government Code Claim Compliance.

3.10.1 Intent. Effective January 1, 1991, Section 20104 et seq., of the California Public Contract Code prescribes a process utilizing informal conferences, non-binding judicial supervised mediation, and judicial arbitration to resolve disputes on construction claims of \$375,000 or less. Effective January 1, 2017, Section 9204 of the Public Contract Code prescribes a process for negotiation and mediation to resolve disputes on construction claims. The intent of this Section is to implement Sections 20104 et seq. and Section 9204 of the California Public Contract Code. This Section shall be construed to be consistent with said statutes.

3.10.2 Claims. For purposes of this Section, "Claim" means a separate demand by the Contractor, after a change order duly requested in accordance with the terms of this Contract has been denied by the City, for (A) a time extension, (B) payment of money or damages arising from Work done by or on behalf of the Contractor pursuant to the Contract, or (C) an amount the payment of which is disputed by the City. Claims governed by this Section may not be filed unless and until the Contractor completes all procedures for giving notice of delay or change and for the requesting of a time extension or change order, including but not necessarily limited to the change order procedures contained herein, and Contractor's request for a change has been denied in whole or in part. Claims governed by this Section must be filed no later than fourteen (14) days after a request for change has been denied in whole or in part or after any other event giving rise to the Claim. The Claim shall be submitted in writing to the City and shall include on its first page the following in 16 point capital font: "THIS IS A CLAIM." Furthermore, the claim shall include the documents necessary to substantiate the claim. Nothing in this Section is intended to extend the

time limit or supersede notice requirements otherwise provided by contract for the filing of claims, including all requirements pertaining to compensation or payment for extra Work, disputed Work, and/or changed conditions. Failure to follow such contractual requirements shall bar any claims or subsequent lawsuits for compensation or payment thereon.

3.10.3 Supporting Documentation. The Contractor shall submit all claims in the following format:

3.10.3.1 Summary of claim merit and price, reference Contract Document provisions pursuant to which the claim is made

- 3.10.3.2 List of documents relating to claim:
- (A) Specifications
 - (B) Drawings
 - (C) Clarifications (Requests for Information)
 - (D) Schedules
 - (E) Other

3.10.3.3 Chronology of events and correspondence

3.10.3.4 Analysis of claim merit

3.10.3.5 Analysis of claim cost

3.10.3.6 Time impact analysis in CPM format

3.10.3.7 If Contractor's claim is based in whole or in part on an allegation of errors or omissions in the Drawings or Specifications for the Project, Contractor shall provide a summary of the percentage of the claim subject to design errors or omissions and shall obtain a certificate of merit in support of the claim of design errors and omissions.

3.10.3.8 Cover letter and certification of validity of the claim, including any claims from subcontractors of any tier, in accordance with Government Code section 12650 *et seq.*

3.10.4 City's Response. Upon receipt of a claim pursuant to this Section, City shall conduct a reasonable review of the claim and, within a period not to exceed 45 days, shall provide the Contractor a written statement identifying what portion of the claim is disputed and what portion is undisputed. Any payment due on an undisputed portion of the claim will be processed and made within 60 days after the public entity issues its written statement.

3.10.4.1 If City needs approval from its governing body to provide the Contractor a written statement identifying the disputed portion and the undisputed portion of the claim, and the governing body does not meet within the 45 days or within the mutually agreed to extension of time following receipt of a claim sent by registered mail or certified mail, return receipt requested, City shall have up to three days following the next duly publicly noticed meeting of the governing body after the 45-day period, or extension, expires to provide the Contractor a written statement identifying the disputed portion and the undisputed portion.

3.10.4.2 Within 30 days of receipt of a claim, City may request in writing additional documentation supporting the claim or relating to defenses or claims City may have against the Contractor. If additional information is thereafter required, it shall be requested and provided pursuant to this subdivision, upon mutual agreement of City and the Contractor.

3.10.4.3 City's written response to the claim, as further documented, shall be submitted to the Contractor within 30 days (if the claim is less than \$50,000, within 15 days) after receipt of the further documentation, or within a period of time no greater than that taken by the Contractor in producing the additional information or requested documentation, whichever is greater.

3.10.5 Meet and Confer. If the Contractor disputes City's written response, or City fails to respond within the time prescribed, the Contractor may so notify City, in writing, either within 15 days of receipt of City's response or within 15 days of City's failure to respond within the time prescribed, respectively, and demand an informal conference to meet and confer for settlement of the issues in dispute. Upon receipt of a demand, City shall schedule a meet and confer conference within 30 days for settlement of the dispute.

3.10.6 Mediation. Within 10 business days following the conclusion of the meet and confer conference, if the claim or any portion of the claim remains in dispute, City shall provide the Contractor a written statement identifying the portion of the claim that remains in dispute and the portion that is undisputed. Any payment due on an undisputed portion of the claim shall be processed and made within 60 days after City issues its written statement. Any disputed portion of the claim, as identified by the Contractor in writing, shall be submitted to nonbinding mediation, with City and the Contractor sharing the associated costs equally. City and Contractor shall mutually agree to a mediator within 10 business days after the disputed portion of the claim has been identified in writing, unless the parties agree to select a mediator at a later time.

3.10.6.1 If the Parties cannot agree upon a mediator, each Party shall select a mediator and those mediators shall select a qualified neutral third party to mediate with regard to the disputed portion of the claim. Each Party shall bear the fees and costs charged by its respective mediator in connection with the selection of the neutral mediator.

3.10.6.2 For purposes of this section, mediation includes any nonbinding process, including, but not limited to, neutral evaluation or a dispute review board, in which an independent third party or board assists the Parties in dispute resolution through negotiation or by issuance of an evaluation. Any mediation utilized shall conform to the timeframes in this section.

3.10.6.3 Unless otherwise agreed to by City and the Contractor in writing, the mediation conducted pursuant to this section shall excuse any further obligation under Section 20104.4 to mediate after litigation has been commenced.

3.10.6.4 The mediation shall be held no earlier than the date the Contractor completes the Work or the date that the Contractor last performs Work, whichever is earlier. All unresolved claims shall be considered jointly in a single mediation, unless a new unrelated claim arises after mediation is completed.

3.10.7 Procedures After Mediation. If following the mediation, the claim or any portion remains in dispute, the Contractor must file a claim pursuant to Chapter 1 (commencing with

Section 900) and Chapter 2 (commencing with Section 910) of Part 3 of Division 3.6 of Title 1 of the Government Code. For purposes of those provisions, the running of the period of time within which a claim must be filed shall be tolled from the time the Contractor submits his or her written claim pursuant to subdivision (a) until the time the claim is denied, including any period of time utilized by the meet and confer conference or mediation.

3.10.8 Civil Actions. The following procedures are established for all civil actions filed to resolve claims subject to this Section:

3.10.8.1 Within 60 days, but no earlier than 30 days, following the filing or responsive pleadings, the court shall submit the matter to non-binding mediation unless waived by mutual stipulation of both parties or unless mediation was held prior to commencement of the action in accordance with Public Contract Code section 9204 and the terms of these procedures.. The mediation process shall provide for the selection within 15 days by both parties of a disinterested third person as mediator, shall be commenced within 30 days of the submittal, and shall be concluded within 15 days from the commencement of the mediation unless a time requirement is extended upon a good cause showing to the court.

3.10.8.2 If the matter remains in dispute, the case shall be submitted to judicial arbitration pursuant to Chapter 2.5 (commencing with Section 1141.10) of Title 3 of Part 3 of the Code of Civil Procedure, notwithstanding Section 1114.11 of that code. The Civil Discovery Act of 1986 (Article 3 (commencing with Section 2016) of Chapter 3 of Title 3 of Part 4 of the Code of Civil Procedure) shall apply to any proceeding brought under this subdivision consistent with the rules pertaining to judicial arbitration.

3.10.8.3 In addition to Chapter 2.5 (commencing with Section 1141.10) of Title 3 of Part 3 of the Code of Civil Procedure, (A) arbitrators shall, when possible, be experienced in construction law, and (B) any party appealing an arbitration award who does not obtain a more favorable judgment shall, in addition to payment of costs and fees under that chapter, also pay the attorney's fees on appeal of the other party.

3.10.9 Government Code Claims. In addition to any and all contract requirements pertaining to notices of and requests for compensation or payment for extra work, disputed work, claims and/or changed conditions, Contractor must comply with the claim procedures set forth in Government Code sections 900 et seq. prior to filing any lawsuit against the City. Such Government Code claims and any subsequent lawsuit based upon the Government Code claims shall be limited to those matters that remain unresolved after all procedures pertaining to extra work, disputed work, claims, and/or changed conditions have been followed by Contractor. If no such Government Code claim is submitted, or if any prerequisite contractual requirements are not otherwise satisfied as specified herein, Contractor shall be barred from bringing and maintaining a valid lawsuit against the City. A Government Code claim must be filed no earlier than the date the work is completed or the date the Contractor last performs work on the Project, whichever occurs first. A Government Code claim shall be inclusive of all unresolved claims unless a new unrelated claim arises after the Government Code claim is submitted.

3.10.10 Non-Waiver. City's failure to respond to a claim from the Contractor within the time periods described in this Section or to otherwise meet the time requirements of this Section shall result in the claim being deemed rejected in its entirety. City's failure to respond shall not waive City's rights to any subsequent procedures for the resolution of disputed claims.

3.11 Loss and Damage. Except as may otherwise be limited by law, Contractor shall be responsible for all loss and damage which may arise out of the nature of the Work agreed to herein, or from the action of the elements, or from any unforeseen difficulties which may arise or be encountered in the prosecution of the Work until the same is fully completed and accepted by City.

3.12 Indemnification.

3.12.1 Scope of Indemnity. To the fullest extent permitted by law, Contractor shall defend, indemnify and hold the City, its officials, employees, agents and authorized volunteers free and harmless from any and all claims, demands, causes of action, suits, actions, proceedings, costs, expenses, liability, judgments, awards, decrees, settlements, loss, damage or injury of any kind, in law or equity, to property or persons, including wrongful death, (collectively, "Claims") in any manner arising out of, pertaining to, or incident to any alleged acts, errors or omissions, or willful misconduct of Contractor, its officials, officers, employees, subcontractors, consultants or agents in connection with the performance of the Contractor's services, the Project or this Agreement, including without limitation the payment of all consequential damages, expert witness fees and attorneys' fees and other related costs and expenses. Notwithstanding the foregoing, to the extent required by Civil Code section 2782, Contractor's indemnity obligation shall not apply to liability for damages for death or bodily injury to persons, injury to property, or any other loss, damage or expense arising from the sole or active negligence or willful misconduct of the City or the City's agents, servants, or independent contractors who are directly responsible to the City, or for defects in design furnished by those persons.

3.12.2 Additional Indemnity Obligations. Contractor shall defend, with counsel of City's choosing and at Contractor's own cost, expense and risk, any and all Claims covered by this section that may be brought or instituted against City or its officials, employees, agents and authorized volunteers. In addition, Contractor shall pay and satisfy any judgment, award or decree that may be rendered against City or its officials, employees, agents and authorized volunteers as part of any such claim, suit, action or other proceeding. Contractor shall also reimburse City for the cost of any settlement paid by City or its officials, employees, agents and authorized volunteers as part of any such claim, suit, action or other proceeding. Such reimbursement shall include payment for City's attorney's fees and costs, including expert witness fees. Contractor shall reimburse City and its officials, employees, agents and authorized volunteers, for any and all legal expenses and costs incurred by each of them in connection therewith or in enforcing the indemnity herein provided. Contractor's obligation to indemnify shall not be restricted to insurance proceeds, if any, received by the City, its officials, employees, agents and authorized volunteers.

3.13 Insurance.

3.13.1 Time for Compliance. Contractor shall not commence Work under this Contract until it has provided evidence satisfactory to the City that it has secured all insurance required under this section. In addition, Contractor shall not allow any subcontractor to commence work on any subcontract until it has provided evidence satisfactory to the City that the subcontractor has secured all insurance required under this section. Failure to provide and maintain all required insurance shall be grounds for the City to terminate this Contract for cause.

3.13.2 Minimum Requirements. Contractor shall, at its expense, procure and maintain for the duration of the Contract insurance against claims for injuries to persons or damages to property which may arise from or in connection with the performance of the Work hereunder by Contractor, its agents, representatives, employees or subcontractors. Contractor

shall also require all of its subcontractors to procure and maintain the same insurance for the duration of the Contract. Such insurance shall meet at least the following minimum levels of coverage:

3.13.2.1 Minimum Scope of Insurance. Coverage shall be at least as broad as the latest version of the following: (1) *General Liability*: Insurance Services Office Commercial General Liability coverage (occurrence form CG 00 01) OR Insurance Services Office Owners and Contractors Protective Liability Coverage Form (CG 00 09 11 88) (coverage for operations of designated contractor); (2) *Automobile Liability*: Insurance Services Office Business Auto Coverage form number CA 00 01, code 1 (any auto); and (3) *Workers' Compensation and Employer's Liability*: Workers' Compensation insurance as required by the State of California and Employer's Liability Insurance. Policies shall not contain exclusions contrary to this Contract.

3.13.2.2 Minimum Limits of Insurance. Contractor shall maintain limits no less than: (1) *General Liability*: \$5,000,000 per occurrence and \$5,000,000 aggregate for bodily injury, personal injury and property damage; (2) *Automobile Liability*: \$5,000,000 per accident for bodily injury and property damage; and (3) *Workers' Compensation and Employer's Liability*: Workers' compensation limits as required by the Labor Code of the State of California. Employer's Liability limits of \$1,000,000 each accident, policy limit bodily injury or disease, and each employee bodily injury or disease. Defense costs shall be available in addition to the limits. Notwithstanding the minimum limits specified herein, any available coverage shall be provided to the parties required to be named as additional insureds pursuant to this Contract.

3.13.3 Insurance Endorsements. The insurance policies shall contain the following provisions, or Contractor shall provide endorsements (amendments) on forms supplied or approved by the City to add the following provisions to the insurance policies:

3.13.3.1 General Liability. (1) Such policy shall give the City, its officials, employees, agents and authorized volunteers additional insured status using ISO endorsements CG20 10 10 01 plus CG20 37 10 01, or endorsements providing the exact same coverage, with respect to the Work or operations performed by or on behalf of Contractor, including materials, parts or equipment furnished in connection with such work; (2) all policies shall waive or shall permit Contractor to waive all rights of subrogation which may be obtained by the Contractor or any insurer by virtue of payment of any loss or any coverage provided to any person named as an additional insured pursuant to this Contract, and Contractor agrees to waive all such rights of subrogation; and (3) the insurance coverage shall be primary insurance as respects the City, its officials, employees, agents and authorized volunteers, or if excess, shall stand in an unbroken chain of coverage excess of Contractor's scheduled underlying coverage. Any insurance or self-insurance maintained by the City, its officials, employees, agents and authorized volunteers shall be excess of Contractor's insurance and shall not be called upon to contribute with it.

3.13.3.2 Automobile Liability. (1) Such policy shall give the City, its officials, employees, agents and authorized volunteers additional insured status with respect to the ownership, operation, maintenance, use, loading or unloading of any auto owned, leased, hired or borrowed by Contractor or for which Contractor is responsible; (2) all policies shall waive or shall permit Contractor to waive all rights of subrogation which may be obtained by the Contractor or any insurer by virtue of payment of any loss or any coverage provided to any person named as an additional insured pursuant to this Contract, and Contractor agrees to waive all such rights of subrogation; and (3) the insurance coverage shall be primary insurance as respects the City, its officials, employees, agents and authorized volunteers, or if excess, shall stand in an unbroken chain of coverage excess of Contractor's scheduled underlying coverage. Any insurance or self-

insurance maintained by the City, its officials, employees, agents and authorized volunteers shall be excess of Contractor's insurance and shall not be called upon to contribute with it in any way.

3.13.3.3 Workers' Compensation and Employer's Liability Coverage. The insurer shall agree to waive all rights of subrogation against the City, its officials, employees, agents and authorized volunteers for losses paid under the terms of the insurance policy which arise from work performed by Contractor.

3.13.3.4 All Coverages. Each insurance policy required by this Contract shall be endorsed to state that: (1) coverage shall not be suspended, voided, reduced or canceled except after thirty (30) days prior written notice by certified mail, return receipt requested, has been given to the City; and (2) any failure to comply with reporting or other provisions of the policies, including breaches of warranties, shall not affect coverage provided to the City, its officials, employees, agents and authorized volunteers.

3.13.4 Separation of Insureds; No Special Limitations. All insurance required by this Section shall contain standard separation of insureds provisions. In addition, such insurance shall not contain any special limitations on the scope of protection afforded to the City, its officials, employees, agents and authorized volunteers.

3.13.5 Deductibles and Self-Insurance Retentions. Any deductibles or self-insured retentions must be declared to and approved by the City. Contractor shall guarantee that, at the option of the City, either: (1) the insurer shall reduce or eliminate such deductibles or self-insured retentions as respects the City, its officials, employees, agents and authorized volunteers; or (2) the Contractor shall procure a bond or other financial guarantee acceptable to the City guaranteeing payment of losses and related investigation costs, claims and administrative and defense expenses.

3.13.6 Acceptability of Insurers. Insurance is to be placed with insurers with a current A.M. Best's rating no less than A:VII, licensed to do business in California, and satisfactory to the City. Exception may be made for the State Compensation Insurance Fund when not specifically rated.

3.13.7 Verification of Coverage. Contractor shall furnish City with original certificates of insurance and endorsements effecting coverage required by this Contract on forms satisfactory to the City. The certificates and endorsements for each insurance policy shall be signed by a person authorized by that insurer to bind coverage on its behalf, and shall be on forms supplied or approved by the City. All certificates and endorsements must be received and approved by the City before work commences. The City reserves the right to require complete, certified copies of all required insurance policies, at any time.

3.13.8 Subcontractors. All subcontractors shall meet the requirements of this Section before commencing Work. Contractor shall furnish separate certificates and endorsements for each subcontractor. Subcontractor policies of General Liability insurance shall name the City, its officials, employees, agents and authorized volunteers as additional insureds using form ISO 20 38 04 13 or endorsements providing the exact same coverage. All coverages for subcontractors shall be subject to all of the requirements stated herein except as otherwise agreed to by the City in writing.

3.13.9 Reporting of Claims. Contractor shall report to the City, in addition to Contractor's insurer, any and all insurance claims submitted by Contractor in connection with the Work under this Contract.

3.14 Bond Requirements.

3.14.1 Payment Bond. If required by law or otherwise specifically requested by City in Exhibit "C" attached hereto and incorporated herein by reference, Contractor shall execute and provide to City concurrently with this Contract a Payment Bond in an amount required by the City and in a form provided or approved by the City. If such bond is required, no payment will be made to Contractor until the bond has been received and approved by the City.

3.14.2 Performance Bond. If specifically requested by City in Exhibit "C" attached hereto and incorporated herein by reference, Contractor shall execute and provide to City concurrently with this Contract a Performance Bond in an amount required by the City and in a form provided or approved by the City. If such bond is required, no payment will be made to Contractor until the bond has been received and approved by the City.

3.14.3 Bond Provisions. Should, in City's sole opinion, any bond become insufficient or any surety be found to be unsatisfactory, Contractor shall renew or replace the effected bond within (ten) 10 days of receiving notice from City. In the event the surety or Contractor intends to reduce or cancel any required bond, at least thirty (30) days prior written notice shall be given to the City, and Contractor shall post acceptable replacement bonds at least ten (10) days prior to expiration of the original bonds. No further payments shall be deemed due or will be made under this Contract until any replacement bonds required by this Section are accepted by the City. To the extent, if any, that the Total Contract Price is increased in accordance with the Contract, Contractor shall, upon request of the City, cause the amount of the bond to be increased accordingly and shall promptly deliver satisfactory evidence of such increase to the City. If Contractor fails to furnish any required bond, the City may terminate the Contract for cause.

3.14.4 Surety Qualifications. Only bonds executed by an admitted surety insurer, as defined in California Code of Civil Procedure Section 995.120, shall be accepted. If a California-admitted surety insurer issuing bonds does not meet these requirements, the insurer will be considered qualified if it is in conformance with Section 995.660 of the California Code of Civil Procedure, and proof of such is provided to the City.

3.15 Warranty. Contractor warrants all Work under the Contract (which for purposes of this Section shall be deemed to include unauthorized work which has not been removed and any non-conforming materials incorporated into the Work) to be of good quality and free from any defective or faulty material and workmanship. Contractor agrees that for a period of one year (or the period of time specified elsewhere in the Contract or in any guarantee or warranty provided by any manufacturer or supplier of equipment or materials incorporated into the Work, whichever is later) after the date of final acceptance, Contractor shall within ten (10) days after being notified in writing by the City of any defect in the Work or non-conformance of the Work to the Contract, commence and prosecute with due diligence all Work necessary to fulfill the terms of the warranty at its sole cost and expense. Contractor shall act sooner as requested by the City in response to an emergency. In addition, Contractor shall, at its sole cost and expense, repair and replace any portions of the Work (or work of other contractors) damaged by its defective Work or which becomes damaged in the course of repairing or replacing defective Work. For any Work so corrected, Contractor's obligation hereunder to correct defective Work shall be reinstated for an additional one year period, commencing with the date of acceptance of such corrected Work. Contractor shall

perform such tests as the City may require to verify that any corrective actions, including, without limitation, redesign, repairs, and replacements comply with the requirements of the Contract. All costs associated with such corrective actions and testing, including the removal, replacement, and reinstatement of equipment and materials necessary to gain access, shall be the sole responsibility of Contractor. All warranties and guarantees of subcontractors, suppliers and manufacturers with respect to any portion of the Work, whether express or implied, are deemed to be obtained by Contractor for the benefit of the City, regardless of whether or not such warranties and guarantees have been transferred or assigned to the City by separate agreement and Contractor agrees to enforce such warranties and guarantees, if necessary, on behalf of the City. In the event that Contractor fails to perform its obligations under this Section, or under any other warranty or guaranty under this Contract, to the reasonable satisfaction of the City, the City shall have the right to correct and replace any defective or non-conforming Work and any work damaged by such work or the replacement or correction thereof at Contractor's sole expense. Contractor shall be obligated to fully reimburse the City for any expenses incurred hereunder upon demand.

3.16 Employee/Labor Certifications.

3.16.1 Contractor's Labor Certification. By its signature hereunder, Contractor certifies that he is aware of the provisions of Section 3700 of the California Labor Code which require every employer to be insured against liability for Worker's Compensation or to undertake self-insurance in accordance with the provisions of that Code, and agrees to comply with such provisions before commencing the performance of the Work. A certification form for this purpose, which is attached to this Contract as Exhibit "D" and incorporated herein by reference, shall be executed simultaneously with this Contract.

3.16.2 Equal Opportunity Employment. Contractor represents that it is an equal opportunity employer and that it shall not discriminate against any employee or applicant for employment because of race, religion, color, national origin, ancestry, sex, age or other interests protected by the State or Federal Constitutions. Such non-discrimination shall include, but not be limited to, all activities related to initial employment, upgrading, demotion, transfer, recruitment or recruitment advertising, layoff or termination.

3.16.3 Verification of Employment Eligibility. By executing this Contract, Contractor verifies that it fully complies with all requirements and restrictions of state and federal law respecting the employment of undocumented aliens, including, but not limited to, the Immigration Reform and Control Act of 1986, as may be amended from time to time, and shall require all subcontractors and sub-subcontractors to comply with the same.

3.17 General Provisions.

3.17.1 City's Representative. The City hereby designates the General Manager, or his or her designee, to act as its representative for the performance of this Contract ("City's Representative"). City's Representative shall have the power to act on behalf of the City for all purposes under this Contract. Contractor shall not accept direction or orders from any person other than the City's Representative or his or her designee.

3.17.2 Contractor's Representative. Before starting the Work, Contractor shall submit in writing the name, qualifications and experience of its proposed representative who shall be subject to the review and approval of the City ("Contractor's Representative"). Following approval by the City, Contractor's Representative shall have full authority to represent and act on behalf of Contractor for all purposes under this Contract. Contractor's Representative shall

supervise and direct the Work, using his best skill and attention, and shall be responsible for all construction means, methods, techniques, sequences and procedures and for the satisfactory coordination of all portions of the Work under this Contract. Contractor's Representative shall devote full time to the Project and either he or his designee, who shall be acceptable to the City, shall be present at the Work site at all times that any Work is in progress and at any time that any employee or subcontractor of Contractor is present at the Work site. Arrangements for responsible supervision, acceptable to the City, shall be made for emergency Work which may be required. Should Contractor desire to change its Contractor's Representative, Contractor shall provide the information specified above and obtain the City's written approval.

3.17.3 Termination. This Contract may be terminated by City at any time, either with or without cause, by giving Contractor three (3) days advance written notice. In the event of termination by City for any reason other than the fault of Contractor, City shall pay Contractor for all Work performed up to that time as provided herein. In the event of breach of the Contract by Contractor, City may terminate the Contract immediately without notice, may reduce payment to Contractor in the amount necessary to offset City's resulting damages, and may pursue any other available recourse against Contractor. Contractor may not terminate this Contract except for cause. In the event this Contract is terminated in whole or in part as provided, City may procure, upon such terms and in such manner as it may determine appropriate, services similar to those terminated. Further, if this Contract is terminated as provided, City may require Contractor to provide all finished or unfinished documents, data, diagrams, drawings, materials or other matter prepared or built by Contractor in connection with its performance of this Contract.

3.17.4 Contract Interpretation. Should any question arise regarding the meaning or import of any of the provisions of this Contract or written or oral instructions from City, the matter shall be referred to City's Representative, whose decision

3.17.5 Anti-Trust Claims. This provision shall be operative if this Contract is applicable to California Public Contract Code Section 7103.5. In entering into this Contract to supply goods, services or materials, Contractor hereby offers and agrees to assign to the City all rights, title, and interest in and to all causes of action it may have under Section 4 of the Clayton Act (15 U.S.C. Section 15) or under the Cartwright Act (Chapter 2, commencing with Section 16700, of Part 2 of Division 7 of the Business and Professions Code) arising from purchases of goods, services, or materials pursuant to the Contract. This assignment shall be made and become effective at the time the City tender final payment to Contractor, without further acknowledgment by the Parties.

3.17.6 Notices. All notices hereunder and communications regarding interpretation of the terms of the Contract or changes thereto shall be provided by the mailing thereof by registered or certified mail, return receipt requested, postage prepaid and addressed as follows:

CONTRACTOR:

American Paving Co.
525 W Alluvial Avenue
Fresno, CA 93711
Stephen J. Poindexter, President

CITY:

City of Merced
2525 "O" Street
Merced, California 95340
Attn: Mr. Richard Maddox, PE
Interim City Engineer

Any notice so given shall be considered received by the other Party three (3) days after deposit in the U.S. Mail as stated above and addressed to the Party at the above address. Actual notice shall be deemed adequate notice on the date actual notice occurred, regardless of the method of service.

3.17.7 Time of Essence. Time is of the essence in the performance of this Contract.

3.17.8 Assignment Forbidden. Contractor shall not, either voluntarily or by action of law, assign or transfer this Contract or any obligation, right, title or interest assumed by Contractor herein without the prior written consent of City. If Contractor attempts an assignment or transfer of this Contract or any obligation, right, title or interest herein, City may, at its option, terminate and revoke the Contract and shall thereupon be relieved from any and all obligations to Contractor or its assignee or transferee.

3.17.9 No Third Party Beneficiaries. There are no intended third party beneficiaries of any right or obligation assumed by the Parties.

3.17.10 Governing Laws; Venue. This Agreement shall be interpreted in accordance with the laws of the State of California. If any action is brought to interpret or enforce any term of this Agreement, the action shall be brought in a state or federal court situated in the County of Merced, State of California.

3.17.11 Counterparts. This Contract may be executed in counterparts, each of which shall constitute an original.

3.17.12 Successors. The Parties do for themselves, their heirs, executors, administrators, successors, and assigns agree to the full performance of all of the provisions contained in this Contract.

3.17.13 [Reserved]

3.17.14 Solicitation. Contractor maintains and warrants that it has not employed nor retained any company or person, other than a bona fide employee working solely for Contractor, to solicit or secure this Contract. Further, Contractor warrants that it has not paid nor has it agreed to pay any company or person, other than a bona fide employee working solely for Contractor, any fee, commission, percentage, brokerage fee, gift or other consideration contingent upon or resulting from the award or making of this Contract. For breach or violation of this warranty, City shall have the right to terminate this Contract without liability.

3.17.15 Conflict of Interest. Contractor maintains and warrants that it has not employed nor retained any company or person, other than a bona fide employee working solely for Contractor, to solicit or secure this Agreement. Further, Contractor warrants that it has not paid nor has it agreed to pay any company or person, other than a bona fide employee working

solely for Contractor, any fee, commission, percentage, brokerage fee, gift or other consideration contingent upon or resulting from the award or making of this Agreement. For breach or violation of this warranty, City shall have the right to rescind this Agreement without liability. For the term of this Contract, no official, officer or employee of City, during the term of his or her service with City, shall have any direct interest in this Contract, or obtain any present or anticipated material benefit arising therefrom. In addition, Contractor agrees to file, or to cause its employees or subcontractors to file, a Statement of Economic Interest with the City's Filing Officer as required under state law in the performance of the Work.

3.17.16 Certification of License.

3.17.16.1 Contractor certifies that as of the date of execution of this Contract, Contractor has a current contractor's license of the classification indicated below under Contractor's signature.

3.17.16.2 Contractors are required by law to be licensed and regulated by the Contractors' State License Board which has jurisdiction to investigate complaints against contractors if a complaint regarding a patent act or omission is filed within four (4) years of the date of the alleged violation. A complaint regarding a latent act or omission pertaining to structural defects must be filed within ten (10) years of the date of the alleged violation. Any questions concerning a contractor may be referred to the Registrar, Contractors' State License Board, P.O. Box 26000, Sacramento, California 95826.

3.17.17 Authority to Enter Contract. Each Party warrants that the individuals who have signed this Contract have the legal power, right and authority to make this Contract and bind each respective Party.

3.17.18 Entire Contract; Modification. This Contract contains the entire agreement of the Parties with respect to the subject matter hereof, and supersedes all prior negotiations, understandings or agreements. This Contract may only be modified by a writing signed by both Parties.

3.17.19 Non-Waiver. None of the provisions of this Agreement shall be considered waived by either party, unless such waiver is specifically specified in writing.

3.17.20 City's Right to Employ Other Contractors. City reserves right to employ other contractors in connection with this Project or other projects.

[SIGNATURES ON NEXT PAGE]

**SIGNATURE PAGE FOR CONSTRUCTION CONTRACT
BETWEEN THE CITY OF MERCED
AND
AMERICAN PAVING CO.**

IN WITNESS WHEREOF, the Parties have entered into this Agreement as of the _____ day of _____, 2024.

CITY OF MERCED

AMERICAN PAVING CO.

By: _____
Scott McBride
City Manager

By:  _____
Its: President 10/15/24
Printed Name: Stephen J. Poindexter

ATTEST:

By: 181430
Contractor licensed in accordance with an
act providing for the registration of contractors.

By: _____
Deputy City Clerk

Taxpayer ID No.: 94-1484960
Vendor No.: _____
Address: 525 W. Alluvial Avenue
Fresno, CA 93711
Phone: (559) 441-1900
Fax: (559) 487-7974
Email: spoindexter@americanpavingco.com

(SEAL)

APPROVED AS TO FORM:

By: _____
City Attorney

ACCOUNT DATA:

Project No.: CP230066 – G Street Bridge Repair

Project Account Number(s) / Amount:

By: _____

Finance Officer Verification

EXHIBIT “A” - SERVICES / SCHEDULE

The work to be performed includes, but not limited to, the reconstruction of approximately 30 lineal feet of metal bridge railing and electrical conduit along the north side of Bear Creek Bridge crossing over Bear Creek.

All work shall be completed in accordance with the 2023 *Caltrans Standard Specifications, Caltrans Standard Plans*, and supplemented by the technical provisions shown in Exhibit B.

~~Such other items or details, not mentioned above, that are required by the Drawings and Technical Specifications Plans, City of Merced Standard Specifications and Typical Details, and the Special Conditions shall be performed, placed, constructed, or installed.~~

The project is located at the Bear Creek Bridge crossing over Bear Creek in the City of Merced. Bear Creek bridge carries G street. Bids are required for the entire work described herein.

The work shall be Completed within 45 working days of Notice to Proceed.

BID SCHEDULE

ITEM NO.	CALTRANS ITEM NO	ITEM	UNIT OF MEASURE	ESTIMATED QUANTITY	UNIT PRICE (IN FIGURES)	ITEM TOTAL (IN FIGURES)
1	120000A	Public Convenience and Safety	LS	1	\$20,000.00	\$20,000.00
2	128651	Portable Changeable Message Sign	EA	4	\$325.00	\$1,300.00
3	130100	Job Site Management	LS	1	\$3,720.00	\$3,720.00
4	510502 (F)	MINOR CONCRETE (MINOR STRUCTURE)	CY	2	\$3,600.00	\$7,200.00
5	511106	DRILL AND BOND DOWEL	LF	12	\$515.00	\$6,180.00
7	600114	BRIDGE REMOVAL (PORTION)	LS	1	\$28,900.00	\$28,900.00
8	839790	RECONSTRUCT METAL RAILING (BRIDGE)	LF	30	\$2,100.00	\$63,000.00
9	872131A	RECONSTRUCT CONDUIT (BRIDGE)	LS	1	\$5,000.00	\$5,000.00
10	999990	Mobilization	LS	1	\$13,100.00	\$13,100.00
TOTAL BID						\$148,400.00

(F) = Final Pay

INDEX OF PLANS

1	TITLE SHEET
2	GENERAL PLAN
3	RECONSTRUCT METAL RAILING DETAILS
4	RECONSTRUCT CONDUIT DETAILS

CITY OF MERCED
DEPARTMENT OF ENGINEERING
CONSTRUCTION PLANS FOR
G STREET RAILING REPAIR
AT BEAR CREEK BRIDGE ALONG G STREET
TO BE SUPPLEMENTED BY THE 2023 CALTRANS SPECIFICATIONS AND STANDARD PLANS
PROJECT NO. CP230066

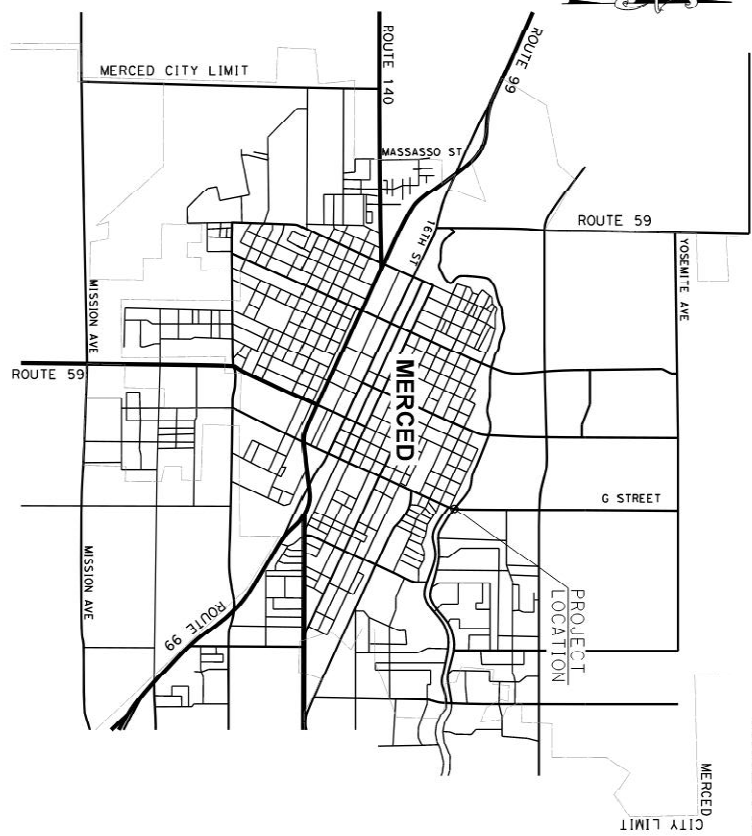
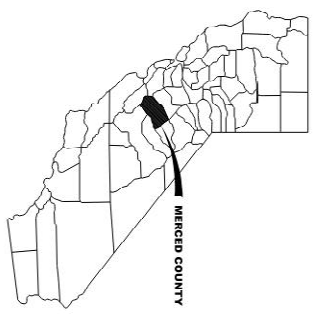

GENERAL NOTES

1. ALL WORK SHALL BE DONE IN ACCORDANCE WITH 2023 CALTRANS STANDARD SPECIFICATIONS AND SUPPLEMENTED WITH THE TECHNICAL SPECIFICATIONS.
2. THE CONTRACTOR SHALL BE SOLELY RESPONSIBLE FOR FURNISHING, INSTALLING AND MAINTAINING ALL TRAFFIC CONTROL DEVICES AND SIGNAGE THROUGHOUT THE GENERAL PUBLIC AND THE WORK, AND FOR PROVIDING PROPER AND SAFE ROUTING OF THE VEHICULAR AND PEDESTRIAN TRAFFIC DURING THE PERFORMANCE OF THE WORK. THIS REQUIREMENT SHALL APPLY CONTINUOUSLY AND SHALL NOT BE LIMITED TO WORKING HOURS. THE CONTRACTOR SHALL OBTAIN ALL NECESSARY PERMITS AND SHALL COMPLY WITH THE CURRENT EDITION OF THE CALIFORNIA MUTICOD.
3. THE CONTRACTOR IS RESPONSIBLE FOR DETERMINING THE LOCATION OF ALL EXISTING UTILITIES AND PROTECTING AND REPAIRING DAMAGE TO EXISTING UTILITIES. THE CONTRACTOR SHALL BE RESPONSIBLE FOR PROVIDING A SERVICE ALERT (1-800-642-2444) TWO WORKING DAYS PRIOR TO WORK COMMENCEMENT.
4. THE RESIDENT ENGINEER SHALL DETERMINE THE EXACT LIMITS OF CONCRETE REMOVAL IN LINE A VARIATION OF 2-1/2" DEEP.
5. DEMOLITION OF EXISTING FEATURES SHALL BE LIMITED TO THE ITEMS SHOWN ON THE PLANS AND DESCRIBED IN THE SPECIAL PROVISIONS. IT SHALL BE THE CONTRACTOR'S RESPONSIBILITY TO REPAIR AND/OR REPLACE ALL EXISTING FEATURES DAMAGED BY HIS OPERATIONS, AT THEIR EXPENSE.
6. THE CONTRACTOR SHALL BE COMPLETELY RESPONSIBLE FOR PRESERVING ALL EXISTING MONUMENTS WHICH WILL BE DISTURBED OR REMOVED AS REQUIRED BY CONTRACTOR'S WORK. CONTRACTOR SHALL COORDINATE WITH ENGINEER/SURVEYOR PRIOR TO DISTURBANCE OF ANY MONUMENTS AND FILE DOCUMENTATION WITH THE COUNTY SURVEYOR PERSUANT TO BUSINESS AND PROFESSIONS CODE.

NO DATE	BY	REVISIONS

Underground Service Alert
TWO DAYS BEFORE YOU DIG
Call toll free: 1 (800) 327-2800

City of Merced
ENGINEERING DEPARTMENT
609 W. 10th Street
Merced, CA 95354

DEDOKKEN
ENGINEERING
110 BEECHER ROAD, SUITE 200, FRESNO, CA, 93705-5442

G STREET RAILING REPAIR
TITLE SHEET

DATE OF LAST APPROVAL: 12/17/2023
BY: M. M. M. M. M.
SCALE: AS SHOWN

Sheet No. **1** of **4**

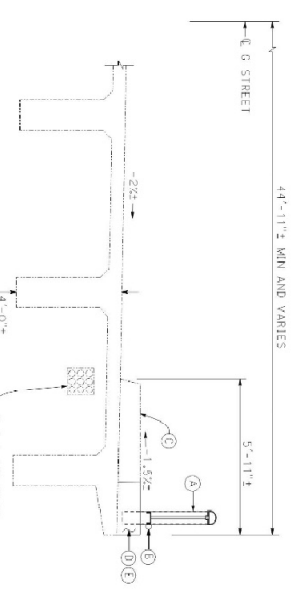
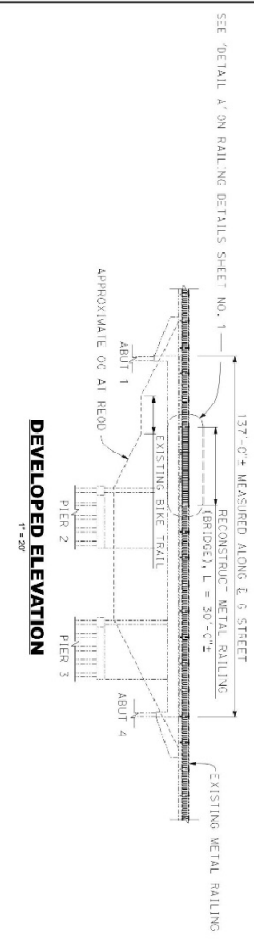

SECTION A-A
1/2" = 1'-0"

QUANTITIES

ITEM	QUANTITY
Public Convenience and Safety	1 LS
Portable Changeable Message Sign	4 EA
Concrete Monopilot	1 LS
Bridge Removal (Portion)	1 LS
Reconstruct Metal Railing (Bridge)	30 LF
Minor Concrete (Minor Structure)	1 CY
Dr-11 and Sand Dowe	12 LF
Reconstruct Conduit (Bridge)	1 LS

LEGEND

- ⊕ RECONSTRUCT METAL RAILING (BRIDGE)
- ⊕ RECONSTRUCT CONDUIT (BRIDGE)
- ⊕ EXISTING SIDEWALK
- ⊕ MINOR CONCRETE (MINOR STRUCTURE)
- ⊕ BRIDGE REMOVAL (PORTION)

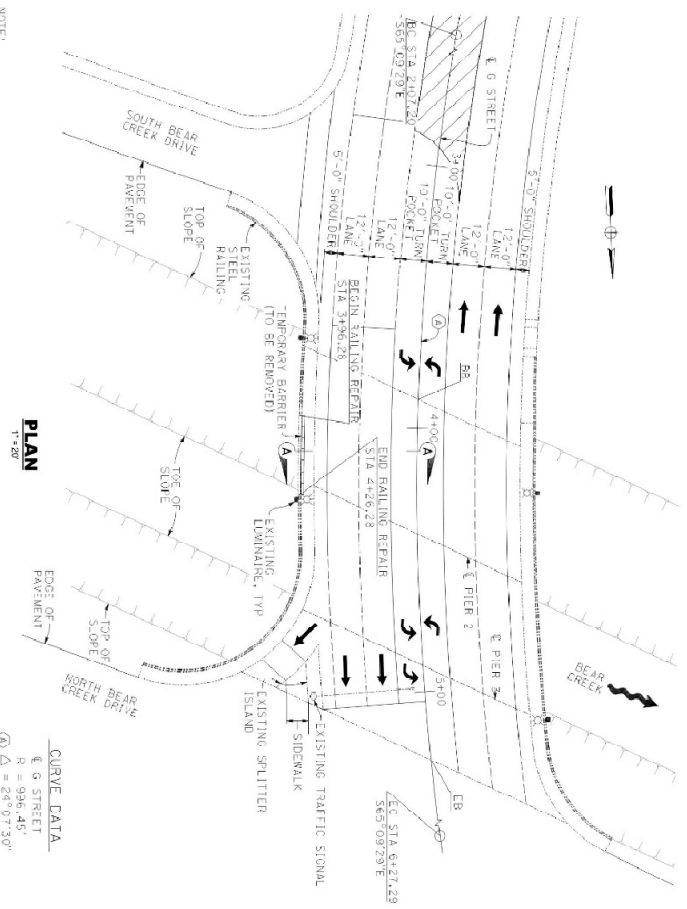

PLAN
1" = 20'

NOTE:
THE CONTRACTOR SHALL VERIFY ALL EXISTING UTILITIES AND DEPT. OF TRANSPORTATION RECORDS FOR ALL UTILITIES BEFORE ORDERING OR FABRICATING ANY MATERIAL.

CURVE DATA

⊕ E. G STREET	R = 996.45'
⊕ Δ	Δ = 24° 07' 30"
T	T = 212.94'
L	L = 413.57'

GENERAL NOTES

REINFORCED CONCRETE:
EXISTING
F'C = 3,600 PSI
F'y = 40 KSI
NEW
F'C = 3,600 PSI
F'y = 60 KSI
RAILING STEEL:
T.Y = 50 KSI

STANDARD PLANS DATED 2023

A34	Abbreviations (Sheet 1 of 3)
A38	Abbreviations (Sheet 1 of 3)
A3D	Abbreviations (Sheet 1 of 3)
A10A	Legend - Lines and Symbols (Sheet 1 of 5)
A10B	Legend - Lines and Symbols (Sheet 1 of 5)
A10C	Legend - Lines and Symbols (Sheet 1 of 5)
A10D	Legend - Lines and Symbols (Sheet 1 of 5)
A10E	Legend - Lines and Symbols (Sheet 1 of 5)
A10F	Legend - Lines and Symbols (Sheet 1 of 5)
RP A10G	Legend - Soil (Sheet 1 of 2)
RP A10H	Legend - Soil (Sheet 1 of 2)

NO.	DATE	BY

Underground Service Alert

TWO DAYS BEFORE YOU DIG

Call TOLL FREE 1 (800) 237-2800

City of Merced

ENGINEERING DEPARTMENT

609 N. 11th Street Merced, CA 95354

DEDDOKKEN ENGINEERING

110 BLUE SPRING ROAD, SUITE 200, WALTON, CA 95854

G STREET RAILING REPAIR

GENERAL PLAN

DATE	SCALE	SHEET NO.	TOTAL SHEETS

2

of 4

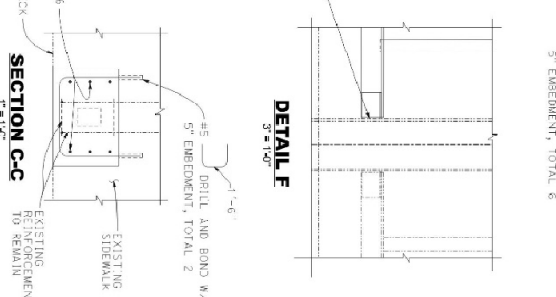
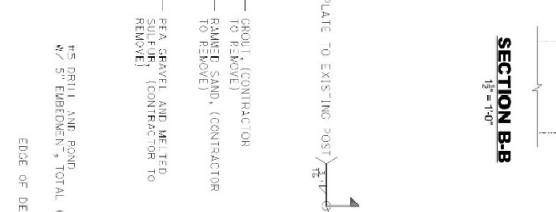
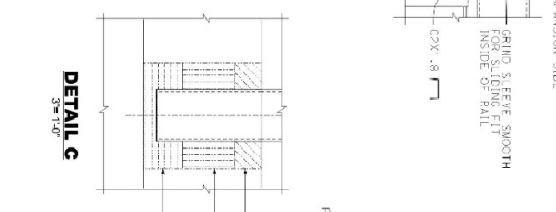
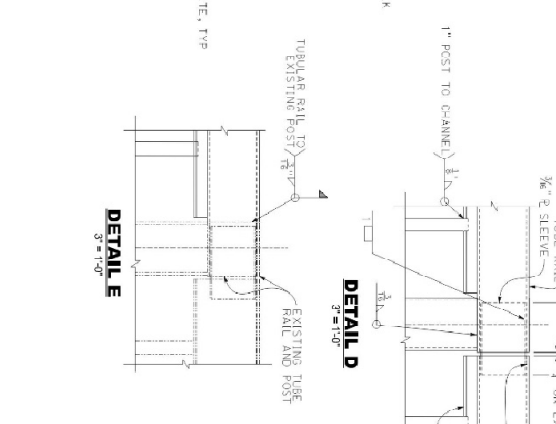
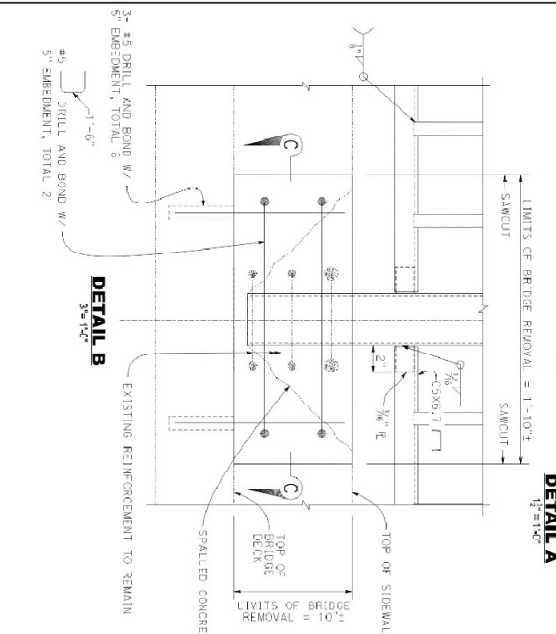
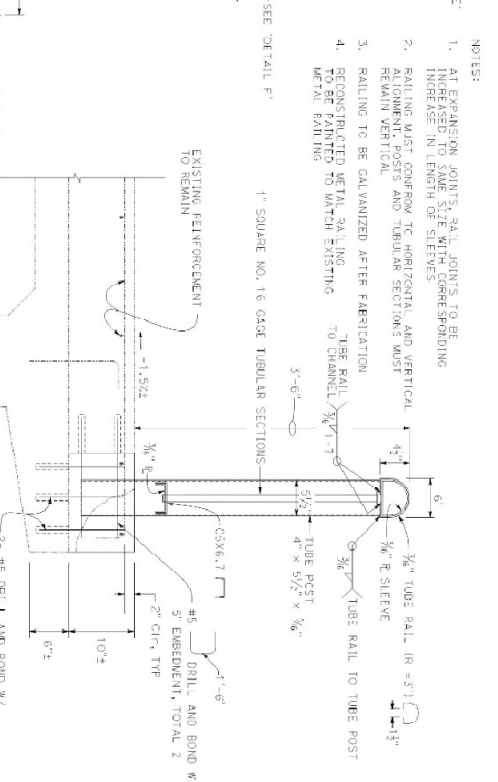
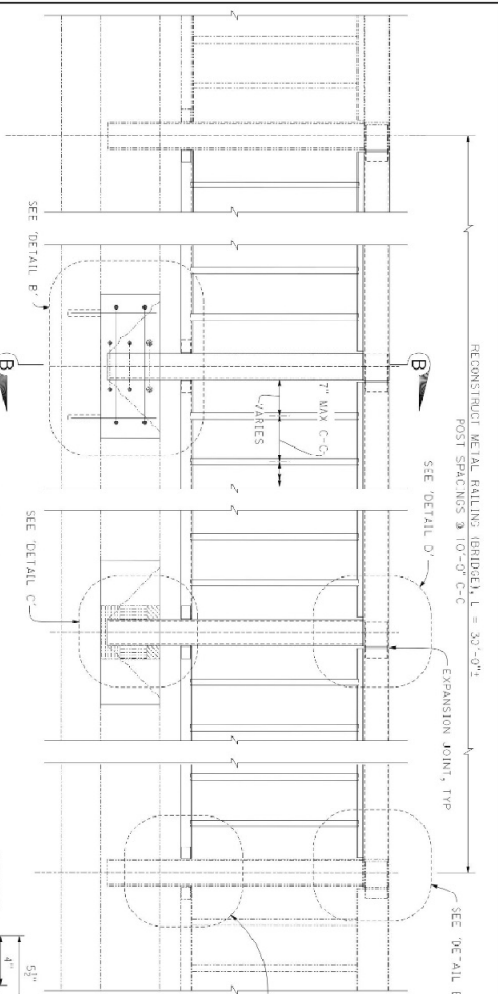

NOTES:

- AT EXPANSION JOINTS, RAIL JOINTS TO BE INCREASED TO SAME SIZE WITH CORRESPONDING INCREASE IN LENGTH OF SLEEVES
- RAILING MUST CONFORM TO HORIZONTAL AND VERTICAL ALIGNMENT. POSTS AND TUBULAR SECTIONS MUST REMAIN VERTICAL
- RAILING TO BE GALVANIZED AFTER FABRICATION
- RECONSTRUCTED METAL RAILING TO BE PAINTED TO MATCH EXISTING METAL FINISH

DETAIL A
1'-10"

DETAIL B
3'-1-1/2"

DETAIL C
3'-1-1/2"

DETAIL D
3'-1-1/2"

DETAIL E
3'-1-1/2"

SECTION B-B
1'-10"

DETAIL F
3'-1-1/2"

SECTION C-C
1'-1-1/2"

CLIENT: _____ **DATE:** _____

SCALE: AS SHOWN

PROJECT: G STREET RAILING REPAIR
RECONSTRUCT METAL RAILING DETAILS

DATE: 10/20/2023
TIME: 10:00 AM
SCALE: AS SHOWN

3
OF 4

Underground Service Alert

TWO DAYS BEFORE YOU DIG

1-800-277-2800

CITY OF MERCED

ENGINEERING DEPARTMENT

1000 STREETS

MERCED, CA 95368

DOKKEN ENGINEERING

1000 STREETS

MERCED, CA 95368

G STREET RAILING REPAIR

RECONSTRUCT METAL RAILING DETAILS

DATE: 10/20/23
TIME: 10:00 AM
SCALE: AS SHOWN

3

OF 4

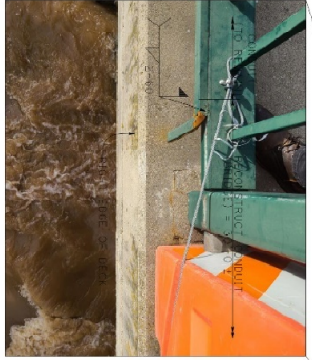
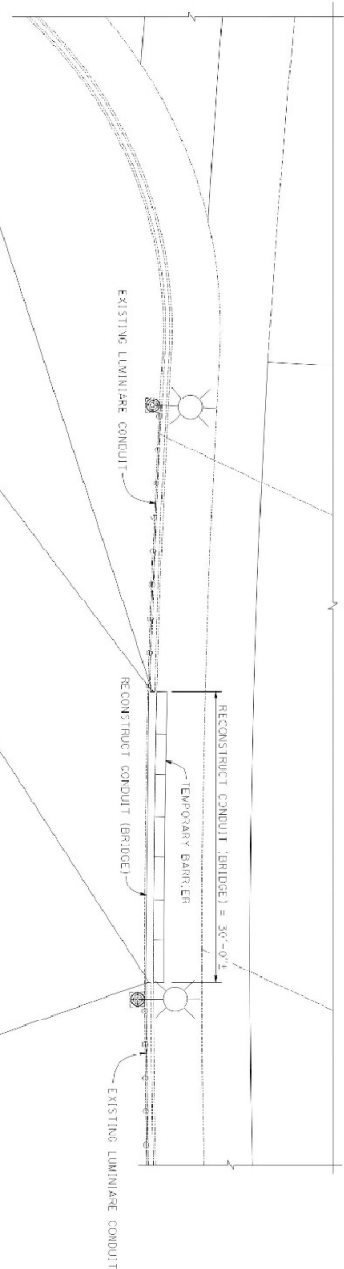

- NOTES:
1. RECONSTRUCT CONDUIT (BRIDGE) INCLUDES ALL CONDUIT, CONDUCTORS, AND ANY ASSOCIATED WORK WITH REPAIRING THE LUMINAIRE SYSTEM.
 2. CONTRACTOR TO TOUCH UP RAW PAINT ON METAL RAILING AFFECTED BY FIELD WELDING.
 3. CONTRACTOR TO CONFIRM EXISTING CONDUIT SIZE AND WIRE TYPE.
 4. CONDUIT TO BE GALVANIZED.

NOTE:
THE CONTRACTOR SHALL VERIFY ALL CONDUIT AND FIELD DIMENSIONS BEFORE BEGINNING WORK TO AVOID ANY CONFLICTS OR INTERFERENCE.

NO.	DATE	BY

Underground Service Alert
TWO DAYS BEFORE YOU DIG
Call Toll Free 1 (800) 227-2830

USE ALL SERVICES AND UTILITIES TO BE MAINTAINED OR MOVED TO AVOID DAMAGE TO THE PROJECT. ANY WORK TO BE COMPLETED BY THE CONTRACTOR.

City of Merced
ENGINEERING DEPARTMENT
209 385-5846

DEDDOKKEN ENGINEERING
11500 BULL STONE ROAD SUITE 100, COLUSA, CA 95925-9541

G STREET RAILING REPAIR
RECONSTRUCT CONDUIT DETAILS

DATE: 07/27/2021
SCALE: AS SHOWN
SHEET NO: 4 OF 4

EXHIBIT “B” - DRAWINGS AND TECHNICAL SPECIFICATIONS

All work shall be completed in accordance with the 2023 *Caltrans Standard Specifications*, *Caltrans Standard Plans*, and supplemented by the technical provisions included herein.

Any paragraph added or deleted by a revision clause does not change the paragraph numbering of the *Caltrans Standard Specifications* for any other reference to a paragraph of the *Caltrans Standard Specifications*.

1. SCOPE OF WORK

The Work to be performed is included in Exhibit B – Drawings and Technical Specifications. Such other items or details, not mentioned above (Exhibit A), that are required by the drawings, and technical specifications, or the following special conditions (Exhibit C) shall be performed, placed, constructed or installed.

2. PERFORMANCE

Furnish all labor, materials, tools, equipment, incidentals, and do all work described in the Plans and these Special Provisions.

3. COORDINATION/COOPERATION

Notify the Engineer at (209) 385-6846 at least three (3) working days in advance of the tentative starting date.

You are responsible for contacting and coordinating with all utility companies, including the City, with regards to the location of existing underground facilities in the construction area. Call Underground Service Alert at (800) 642-2444, at least 2 working days before commencement of underground work for location of underground facilities.

Utility facilities damaged, temporarily disconnected, or relocated as a result of construction must be repaired/reconnected as directed by the governing utility at the your expense.

Full compensation for conforming to the requirements of this is included in the price paid for the various items of work.

4. INSPECTION OF SITE

Inspect the work site and note all existing conditions before submitting a bid for this project. A site tour is scheduled immediately following the pre-bid/LBE meeting if requested.

5. PERMITS, BONDS, LICENSES AND INSURANCE

Procure all permits, bonds, licenses and insurance, pay all charges and fees, and give all notices necessary and incidental to the prosecution of the work.

Full compensation for conforming to the requirements of this is included in the price paid for the various items of work.

6. SURVEYING SERVICES

Arrange for performance of survey work and construction layout. You will be responsible for the accuracy of surveying adequate for construction. The selection of a Surveyor will be subject to approval by the Engineer. Preserve construction survey stakes (if needed) and marks for the duration of their usefulness. If any construction survey stakes are lost or disturbed and need to be replaced, such replacement must be by the Surveyor at your expense. Dig all holes necessary for line and grade stakes.

Full compensation for conforming to the requirements of this is included in the price paid for the various items of work.

7. RECORD DRAWINGS

Record Drawings must be submitted before the notice of completion is filed and must include the following:

- Be submitted on Mylar, at least 24"x 36", and shall bear the name, address, telephone number of the firm preparing the drawings and in electronic (AutoCAD) format.
- Surveyor's/Engineers statement (with embossed or wet seal and with original signature on each sheet) shall verify the as-built drawings reflect the true conditions in the field.
- Contractor's statement (with original signature on each sheet) shall verify all construction specifications and product qualities have been met or exceeded.
- "AS-BUILT DRAWINGS" or "RECORD DRAWINGS" must be clearly labeled on each sheet.
- The location and elevation of the benchmark referenced will be shown on the drawing.
- Corrected placement, grade, elevation and alignment of roads, water system, sewer and storm system, lighting system and appurtenances, pipe sizes, material changes, shall all be shown on as-built drawing.
- All horizontal distances shall be shown to the nearest tenth of a foot (0.1'). All elevations shall be shown to the nearest five hundredths of a foot (0.05').

Full compensation for conforming to the requirements of this is included in the price paid for the various items of work.

8. PUBLIC CONVENIENCE AND SAFETY

Public convenience and safety includes all work associated with section 7-1.03 and section 12 of the Standard Specifications.

You are responsible for all the provisions of this item, including issuance of all notices necessary for prosecution of the work.

Add to the beginning of section 12-3.32C:

Place PCMSs at the locations shown and in advance of the 1st warning sign for each shoulder closure. The location of the PCMSs will be determined by the Engineer.

Start displaying the message on the sign 15 minutes before closing the lane or shoulder or when directed by the Engineer.

Replace the table in the definition of *designated holidays* in section 12-4.02A(2) with:

Designated Holidays

Holiday	Date observed
New Year's Day	January 1st
Washington's Birthday	3rd Monday in February
Memorial Day	Last Monday in May
Independence Day	July 4th
Labor Day	1st Monday in September
Veterans Day	November 11th
Thanksgiving Day	4th Thursday in November
Christmas Day	December 25th

Add to section 12-4.02A(2):

special days: : Mother's Day, Easter Weekend including Friday prior, Martin Luther King Jr Day, day after Thanksgiving

Add to the end of section 12-4.02C(1):

Keep the full width of the traveled way open to traffic when no active construction activities are occurring in the traveled way or within 6 feet of the traveled way and on:

1. Friday after 3:00 p.m.
2. Saturday
3. Sunday
4. Designated holidays
5. Special days

Add to the end of section 12-4.02C(3)(a):

If work vehicles or equipment is parked on the shoulder within 6 feet of a traffic lane along G Street, close the shoulder area with fluorescent-orange traffic cones or portable delineators. Place the cones or delineators on a taper in advance of the parked vehicles or equipment and along the edge of the traveled way at 25-foot intervals to a point not less than 25 feet past the last vehicle or piece of equipment. Use at least 9 cones or delineators for the taper. Place advance warning signs as specified in section 12-4.02C(8).

9. MODIFYING EXISTING STRUCTURES

Add to section 60-2.01A:

Remove the following structures or portions of structures:

Bridge no./Structure name	Description of work
Bear Creek Bridge	Partial removal of sidewalk as required for the reconstruction of the metal railing. Temporary water filled barriers to be returned to City maintenance division. Contractor to coordinate with engineer.

10. RAILINGS AND BARRIERS

Add to section 83-11.03B:

Reconstructed Metal Railing (Bridge) must be painted with an inorganic zinc coating system complying with section 59. Match existing railing color.

11. ELECTRICAL WORK

Add to section 86-1.01A:

Reconstruct Conduit (Bridge) includes all work associated with repairing the luminaire system back to its original operating condition. All work must comply with section 86 and 87. The contractor must match the existing conduit and conductor system on the existing luminaires.

EXHIBIT “C” – SPECIAL CONDITIONS

ARTICLE 1 BONDS

Within ten (10) calendar days from the date the Contractor is notified of award of the Contract, the Contractor shall deliver to the City four identical counterparts of the Performance Bond and Payment Bond on the forms supplied by the City and included as Exhibit “F” to the Contract. Failure to do so may, in the sole discretion of City, result in the forfeiture of Contractor’s bid security. The surety supplying the bond must be an admitted surety insurer, as defined in Code of Civil Procedure Section 995.120, authorized to do business as such in the State of California and satisfactory to the City. The Performance Bond and the Payment Bond shall be for one hundred percent (100%) of the Total Contract Price.

EXHIBIT "D" – CERTIFICATION LABOR CODE SECTION 1861

I, the undersigned Contractor, am aware of the provisions of Section 3700, et seq., of the California Labor Code which require every employer to be insured against liability for Worker's Compensation or to undertake self-insurance in accordance with the provisions of the Code, and I, the undersigned Contractor, agree to and will comply with such provisions before commencing the performance of the Work on this Contract.

American Paving Co.

[INSERT CONTRACTOR NAME]

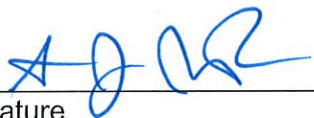
By: _____
Signature

Stephen J. Poindexter

Name (Print)

President

Title (Print)

EXHIBIT "E" – PUBLIC WORKS CONTRACTOR REGISTRATION CERTIFICATION

Pursuant to Labor Code sections 1725.5 and 1771.1, all contractors and subcontractors that wish to bid on, be listed in a bid proposal, or enter into a contract to perform public work must be registered with the Department of Industrial Relations. See <http://www.dir.ca.gov/Public-Works/PublicWorks.html> for additional information.

No bid will be accepted nor any contract entered into without proof of the contractor's and subcontractors' current registration with the Department of Industrial Relations to perform public work.

Contractor hereby certifies that it is aware of the registration requirements set forth in Labor Code sections 1725.5 and 1771.1 and is currently registered as a contractor with the Department of Industrial Relations.¹

Name of Contractor: American Paving Co.

DIR Registration Number: 1000001450

DIR Registration Expiration: 06/30/2025

Small Project Exemption: Yes or No

Unless Contractor is exempt pursuant to the small project exemption, Contractor further acknowledges:

Contractor shall maintain a current DIR registration for the duration of the project.

- Contractor shall include the requirements of Labor Code sections 1725.5 and 1771.1 in its contract with subcontractors and ensure that all subcontractors are registered at the time of bid opening and maintain registration status for the duration of the project.
- Failure to submit this form or comply with any of the above requirements may result in a finding that the bid is non-responsive.

Name of Contractor American Paving Co.

Signature 

Name and Title Stephen J. Poindexter, President

Dated 10/15/24

¹ If the Project is exempt from the contractor registration requirements pursuant to the small project exemption under Labor Code Sections 1725.5 and 1771.1, please mark "Yes" in response to "Small Project Exemption."

**EXHIBIT “F” – PAYMENT AND PERFORMANCE
BONDS**

PERFORMANCE BOND

KNOW ALL PERSONS BY THESE PRESENTS:

THAT WHEREAS, the City of Merced (hereinafter referred to as "City") has awarded to American Paving Co., a California Corporation, (hereinafter referred to as the "Contractor") an agreement for CP230066 G Street Bridge Repair (hereinafter referred to as the "Project").

WHEREAS, the work to be performed by the Contractor is more particularly set forth in the Contract Documents for the Project dated _____, (hereinafter referred to as "Contract Documents"), the terms and conditions of which are expressly incorporated herein by reference; and

WHEREAS, the Contractor is required by said Contract Documents to perform the terms thereof and to furnish a bond for the faithful performance of said Contract Documents.

NOW, THEREFORE, we, American Paving Co., the undersigned Contractor and _____ as Surety, a corporation organized and duly authorized to transact business under the laws of the State of California, are held and firmly bound unto the City in the sum of _____ DOLLARS, (\$ _____), said sum being not less than one hundred percent (100%) of the total amount of the Contract, for which amount well and truly to be made, we bind ourselves, our heirs, executors and administrators, successors and assigns, jointly and severally, firmly by these presents.

THE CONDITION OF THIS OBLIGATION IS SUCH, that, if the Contractor, his or its heirs, executors, administrators, successors or assigns, shall in all things stand to and abide by, and well and truly keep and perform the covenants, conditions and agreements in the Contract Documents and any alteration thereof made as therein provided, on its part, to be kept and performed at the time and in the manner therein specified, and in all respects according to their intent and meaning; and shall faithfully fulfill all obligations including the one-year guarantee of all materials and workmanship; and shall indemnify and save harmless the City, its officers and agents, as stipulated in said Contract Documents, then this obligation shall become null and void; otherwise it shall be and remain in full force and effect.

As a condition precedent to the satisfactory completion of the Contract Documents, unless otherwise provided for in the Contract Documents, the above obligation shall hold good for a period of one (1) year after the acceptance of the work by City, during which time if Contractor shall fail to make full, complete, and satisfactory repair and replacements and totally protect the City from loss or damage resulting from or caused by defective materials or faulty workmanship, Surety shall undertake and faithfully fulfill all such obligations. The obligations of Surety hereunder shall continue so long as any obligation of Contractor remains. Nothing herein shall

limit the City's rights or the Contractor or Surety's obligations under the Contract, law or equity, including, but not limited to, California Code of Civil Procedure section 337.15.

Whenever Contractor shall be, and is declared by the City to be, in default under the Contract Documents, the Surety shall remedy the default pursuant to the Contract Documents, or shall promptly, at the City's option:

- (1) Take over and complete the Project in accordance with all terms and conditions in the Contract Documents; or
- (2) Obtain a bid or bids for completing the Project in accordance with all terms and conditions in the Contract Documents and upon determination by Surety of the lowest responsive and responsible bidder, arrange for a Contract between such bidder, the Surety and the City, and make available as work progresses sufficient funds to pay the cost of completion of the Project, less the balance of the contract price, including other costs and damages for which Surety may be liable. The term "balance of the contract price" as used in this paragraph shall mean the total amount payable to Contractor by the City under the Contract and any modification thereto, less any amount previously paid by the City to the Contractor and any other set offs pursuant to the Contract Documents.
- (3) Permit the City to complete the Project in any manner consistent with local, California and federal law and make available as work progresses sufficient funds to pay the cost of completion of the Project, less the balance of the contract price, including other costs and damages for which Surety may be liable. The term "balance of the contract price" as used in this paragraph shall mean the total amount payable to Contractor by the City under the Contract and any modification thereto, less any amount previously paid by the City to the Contractor and any other set offs pursuant to the Contract Documents.

Surety expressly agrees that the City may reject any contractor or subcontractor which may be proposed by Surety in fulfillment of its obligations in the event of default by the Contractor.

Surety shall not utilize Contractor in completing the Project nor shall Surety accept a bid from Contractor for completion of the Project if the City, when declaring the Contractor in default, notifies Surety of the City's objection to Contractor's further participation in the completion of the Project.

The Surety, for value received, hereby stipulates and agrees that no change, extension of time, alteration or addition to the terms of the Contract Documents or to the Project to be performed thereunder shall in any way affect its obligations on this bond, and it does hereby waive notice of any such change, extension of time, alteration or addition to the terms of the Contract Documents or to the Project, including but not limited to the provisions of sections 2819 and 2845 of the California Civil Code.

IN WITNESS WHEREOF, we have hereunto set our hands and seals this _____ day of _____, 20__).

(Corporate Seal)

Contractor/ Principal

By _____

Title _____

(Corporate Seal)

Surety

By _____

Attorney-in-Fact

Signatures of those signing for the Contractor and Surety must be notarized and evidence of corporate authority attached.

(Attach Attorney-in-Fact Certificate)

Title _____

The rate of premium on this bond is _____ per thousand. The total amount of premium charges, \$_____.

(The above must be filled in by corporate attorney.)

THIS IS A REQUIRED FORM

Any claims under this bond may be addressed to:

(Name and Address of Surety)

(Name and Address of Agent or Representative for service of process in California, if different from above)

(Telephone number of Surety and Agent or Representative for service of process in California)

NOTE: A copy of the Power-of-Attorney authorizing the person signing on behalf of the Surety to do so must be attached hereto.

Notary Acknowledgment

A notary public or other officer completing this certificate verifies only the identity of the individual who signed the document to which this certificate is attached, and not the truthfulness, accuracy, or validity of that document.

STATE OF CALIFORNIA
 COUNTY OF _____

On _____, 20____, before me, _____, Notary Public, personally appeared _____, who proved to me on the basis of satisfactory

evidence to be the person(s) whose name(s) is/are subscribed to the within instrument and acknowledged to me that he/she/they executed the same in his/her/their authorized capacity(ies), and that by his/her/their signature(s) on the instrument the person(s), or the entity upon behalf of which the person(s) acted, executed the instrument.

I certify under PENALTY OF PERJURY under the laws of the State of California that the foregoing paragraph is true and correct.

WITNESS my hand and official seal.

Signature of Notary Public _____

OPTIONAL

Though the information below is not required by law, it may prove valuable to persons relying on the document and could prevent fraudulent removal and reattachment of this form to another document.

CAPACITY CLAIMED BY SIGNER

- Individual
- Corporate Officer

_____ Title(s)

- Partner(s) Limited
- General

- Attorney-In-Fact
- Trustee(s)
- Guardian/Conservator
- Other:

Signer is representing:
 Name Of Person(s) Or Entity(ies)

DESCRIPTION OF ATTACHED DOCUMENT

_____ Title or Type of Document

_____ Number of Pages

_____ Date of Document

_____ Signer(s) Other Than Named Above

PAYMENT BOND

KNOW ALL MEN BY THESE PRESENTS That

WHEREAS, the City of Merced (hereinafter designated as the "City"), by action taken or a resolution passed _____, 20____ has awarded to American Paving Co. hereinafter designated as the "Principal," a contract for the work described as follows:

CP230066 G Street Bridge Repair (the "Project"); and

WHEREAS, the work to be performed by the Principal is more particularly set forth in the Contract Documents for the Project dated _____ ("Contract Documents"), the terms and conditions of which are expressly incorporated by reference; and

WHEREAS, said Principal is required to furnish a bond in connection with said contract; providing that if said Principal or any of its Subcontractors shall fail to pay for any materials, provisions, provender, equipment, or other supplies used in, upon, for or about the performance of the work contracted to be done, or for any work or labor done thereon of any kind, or for amounts due under the Unemployment Insurance Code or for any amounts required to be deducted, withheld, and paid over to the Employment Development Department from the wages of employees of said Principal and its Subcontractors with respect to such work or labor the Surety on this bond will pay for the same to the extent hereinafter set forth.

NOW THEREFORE, we, the Principal and _____ as Surety, are held and firmly bound unto the City in the penal sum of _____ Dollars (\$_____) lawful money of the United States of America, for the payment of which sum well and truly to be made, we bind ourselves, our heirs, executors, administrators, successors and assigns, jointly and severally, firmly by these presents.

THE CONDITION OF THIS OBLIGATION IS SUCH that if said Principal, his or its subcontractors, heirs, executors, administrators, successors or assigns, shall fail to pay any of the persons named in Section 9100 of the Civil Code, fail to pay for any materials, provisions or other supplies, used in, upon, for or about the performance of the work contracted to be done, or for any work or labor thereon of any kind, or amounts due under the Unemployment Insurance Code with respect to work or labor performed under the contract, or for any amounts required to be deducted, withheld, and paid over to the Employment Development Department or Franchise Tax Board from the wages of employees of the contractor and his subcontractors pursuant to Section 18663 of the Revenue and Taxation Code, with respect to such work and labor the Surety or Sureties will pay for the same, in an amount not exceeding the sum herein above specified.

This bond shall inure to the benefit of any of the persons named in Section 9100 of the Civil Code so as to give a right of action to such persons or their assigns in any suit brought upon this bond.

It is further stipulated and agreed that the Surety on this bond shall not be exonerated or released from the obligation of this bond by any change, extension of time for performance, addition, alteration or modification in, to, or of any contract, plans, specifications, or agreement pertaining or relating to any scheme or work of improvement herein above described, or pertaining or relating to the furnishing of labor, materials, or equipment therefore, nor by any change or modification of any terms of payment or extension of the time for any payment pertaining or relating to any scheme or work of improvement herein above described, nor by any rescission or attempted rescission of the contract, agreement or bond, nor by any conditions precedent or subsequent in the bond attempting to limit the right of recovery of claimants otherwise entitled to recover under any such contract or agreement or under the bond, nor by any fraud practiced by any person other than the claimant seeking to recover on the bond and that this bond be construed most strongly against the Surety and in favor of all persons for whose benefit such bond is given, and under no circumstances shall Surety be released from liability to those for whose benefit such bond has been given, by reason of any breach of contract between the owner or City and original contractor or on the part of any obligee named in such bond, but the sole conditions of recovery shall be that claimant is a person described in Section 9100 of the Civil Code, and has not been paid the full amount of his claim and that Surety does hereby waive notice of any such change, extension of time, addition, alteration or modification herein mentioned and the provisions of sections 2819 and 2845 of the California Civil Code.

IN WITNESS WHEREOF, we have hereunto set our hands and seals this _____ day of _____, 20__.

(Corporate Seal)

Contractor/ Principal

By _____

Title _____

(Corporate Seal)

Surety

By _____

Attorney-in-Fact

Title _____

Signatures of those signing for the Contractor and Surety must be notarized and evidence of corporate authority attached. A Power-of-Attorney authorizing the person signing on behalf of the Surety to do so must be attached hereto.

NOTE: A copy of the Power-of-Attorney authorizing the person signing on behalf of the Surety to do so must be attached hereto.

Notary Acknowledgment

A notary public or other officer completing this certificate verifies only the identity of the individual who signed the document to which this certificate is attached, and not the truthfulness, accuracy, or validity of that document.

STATE OF CALIFORNIA
 COUNTY OF _____

On _____, 20____, before me, _____, Notary Public, personally appeared _____, who proved to me on the basis of satisfactory

evidence to be the person(s) whose name(s) is/are subscribed to the within instrument and acknowledged to me that he/she/they executed the same in his/her/their authorized capacity(ies), and that by his/her/their signature(s) on the instrument the person(s), or the entity upon behalf of which the person(s) acted, executed the instrument.

I certify under PENALTY OF PERJURY under the laws of the State of California that the foregoing paragraph is true and correct.

WITNESS my hand and official seal.

Signature of Notary Public _____

OPTIONAL

Though the information below is not required by law, it may prove valuable to persons relying on the document and could prevent fraudulent removal and reattachment of this form to another document.

CAPACITY CLAIMED BY SIGNER

- Individual
- Corporate Officer

_____ Title(s)

- Partner(s) Limited
- General

- Attorney-In-Fact
- Trustee(s)
- Guardian/Conservator
- Other:

Signer is representing:
 Name Of Person(s) Or Entity(ies)

DESCRIPTION OF ATTACHED DOCUMENT

_____ Title or Type of Document

_____ Number of Pages

_____ Date of Document

_____ Signer(s) Other Than Named Above

APPENDIX

CITY OF MERCED STANDARD DESIGNS

THE FOLLOWING STANDARDS ARE FOR REFERENCE ONLY
**REFER TO THE CITY OF MERCED WEBSITE FOR THE COMPLETE LISTING OF
STANDARD DETAILS**

http://www.cityofmerced.org/depts/engineering_division/standard_designs/default.asp

CALTRANS STANDARD PLANS LIST

The standard plan sheets applicable to this Contract include those listed below. The applicable revised standard plans (RSPs) listed below are included in the project plans.

ABBREVIATIONS, LINES, SYMBOLS, AND LEGEND

A3A	Abbreviations (Sheet 1 Of 3)
A3B	Abbreviations (Sheet 2 Of 3)
A3C	Abbreviations (Sheet 3 Of 3)
A10A	Legend - Lines and Symbols (Sheet 1 Of 5)
A10B	Legend - Lines and Symbols (Sheet 2 Of 5)
A10C	Legend - Lines and Symbols (Sheet 3 Of 5)
A10D	Legend - Lines and Symbols (Sheet 4 Of 5)
A10E	Legend - Lines and Symbols (Sheet 5 Of 5)

TEMPORARY TRAFFIC CONTROL SYSTEMS

T9	Traffic Control System Tables for Lane and Ramp Closures
T10	Traffic Control System for Lane Closure on Freeways and Expressways

ROADSIDE SIGNS

RS1	Roadside Signs - Typical Installation Details No. 1
RS2	Roadside Signs - Wood Post - Typical Installation Details No. 2
RS4	Roadside Signs - Typical Installation Details No. 4

STATE GENERAL PREVAILING WAGE RATES

General prevailing wage determination
Made by the Director of Industrial Relations

Pursuant to California Labor Code part 7,
Chapter 1, article 2, sections 1770, 1773, and 1773.1

State of California Department of Industrial Relations Website:

<http://www.dir.ca.gov/OPRL/PWD/index.htm>

LOCATION MAP



LOCATION MAP

	<p>City of Merced "Gateway to Yosemite"</p> <p>DEVELOPMENT SERVICES ENGINEERING PROJECTS AND STANDARDS 678 W. 18th Street (209) 385-6846</p>	<h2>REGIONAL MAP</h2>	<p>DR. BY: CARDOSO DATE: 4/14/20 CH. BY: DATE: FILE NO. SCALE: NONE</p>
--	---	-----------------------	---

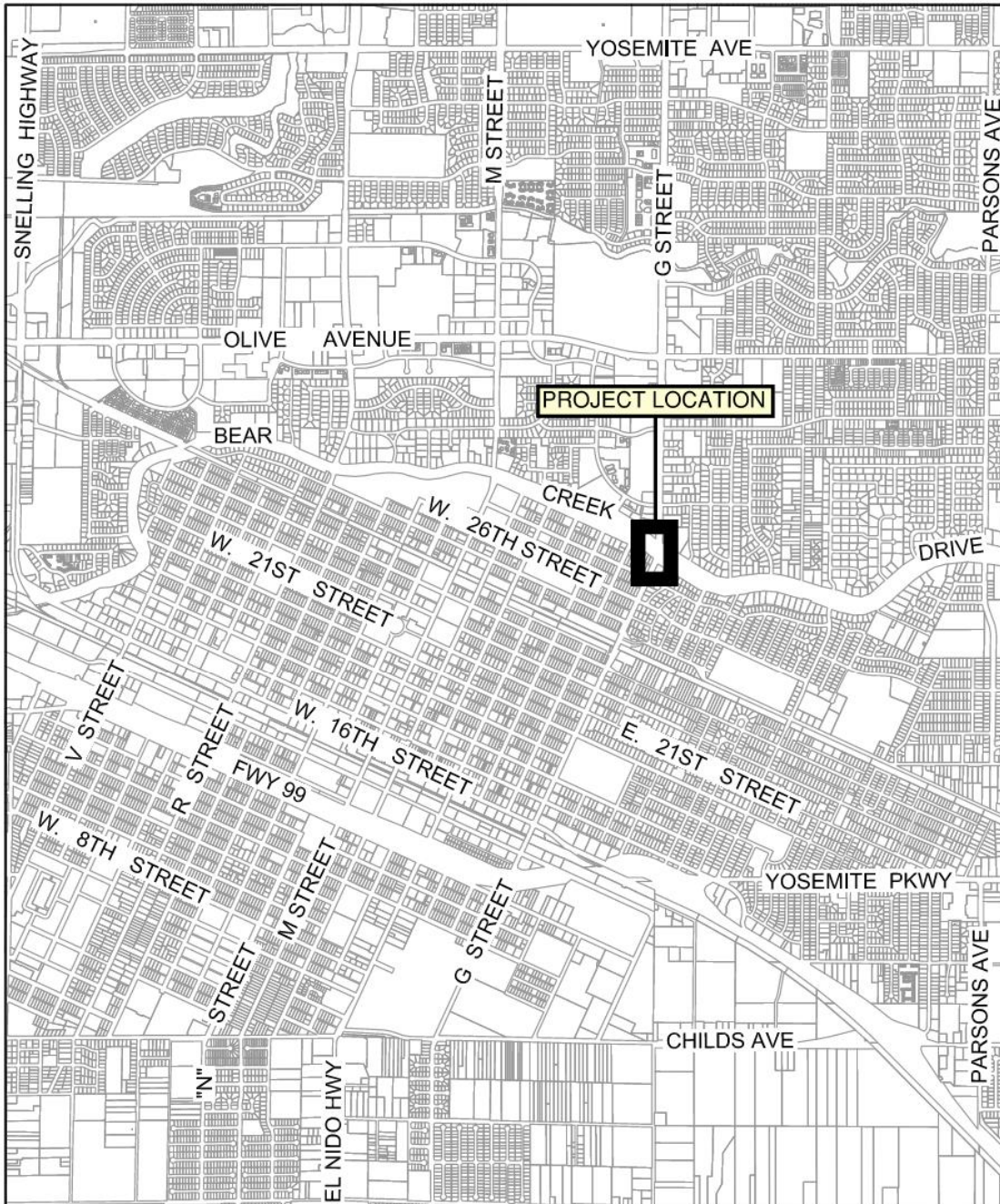



City of Merced
 "Gateway to Yosemite"
DEVELOPMENT SERVICES
 ENGINEERING PROJECTS AND STANDARDS
 678 W. 18th Street (209) 385-6846

PROJECT LOCATION

DR. BY:	CARDOSO
DATE:	9/26/24
CK. BY:	
DATE:	
FILE NO.:	
SCALE:	NONE

PUCHASING DEPARTMENT DRIVING DIRECTIONS

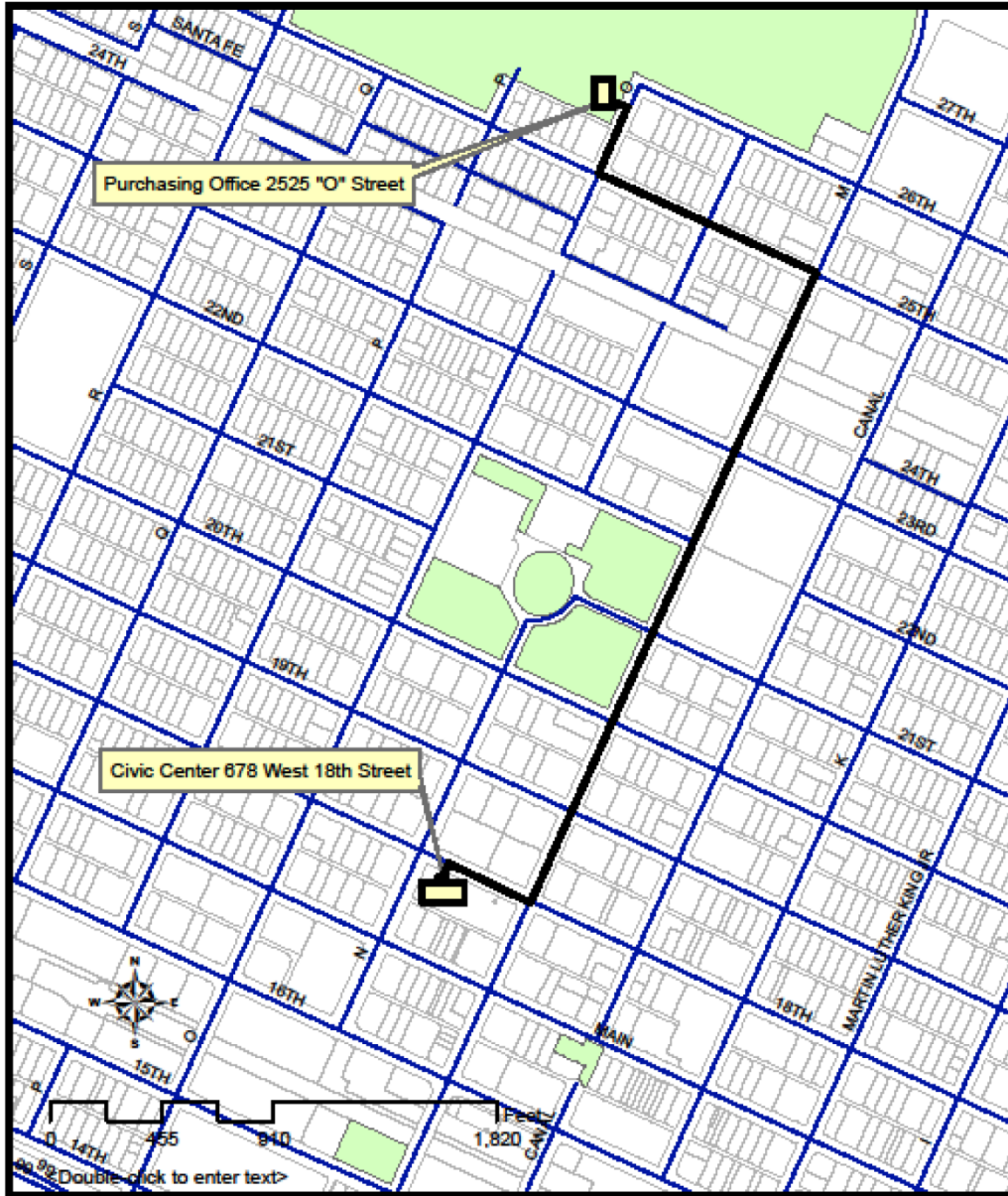
**DRIVING DIRECTIONS
CIVIC CENTER TO
PURCHASING OFFICE**



**DIRECTIONS: DRIVE NORTH ON "M" STREET
TURN LEFT ON WEST 25TH STREET
TURN RIGHT ON "O" STREET**

REGULATION VIII – FUGITIVE PM10 PROHIBITIONS

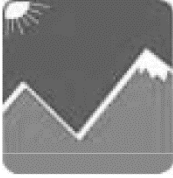

San Joaquin Valley
Air Pollution Control District

COMPLIANCE ASSISTANCE BULLETIN August 2006

Regulation VIII – Fugitive PM10 Prohibitions Requirements on Paved and Unpaved Public Roads

District Rule 8061 (*Paved and Unpaved Roads*) of Regulation VIII (*Fugitive PM10 Prohibitions*) specifies the design criteria for constructing new or modifying existing paved roads and the types of control measures required for limiting fugitive dust emissions from unpaved roads and shoulders. Several compliance dates and deadlines described in the rule apply specifically to city, county, and state agencies. The purpose of this bulletin is to summarize the new requirements for public agencies that own or maintain paved and unpaved roads. The entire rule may be found at www.valleyair.org/rules/1ruleslist.htm - reg8.

- **Constructing New Unpaved Roads:** Effective October 1, 2004, constructing a new unpaved road is prohibited in all urban areas unless the unpaved road is used for a temporary activity that does not exceed six months of use over a consecutive three-year period. Temporary activities may include construction access roads, special events, or traffic detours. The unpaved surface must be maintained in a stabilized condition at all times in order to control fugitive emissions.
- **PM10-Efficient Street Sweepers:** These requirements apply to the routine cleaning of existing paved public roads within urban areas. Effective July 1, 2005, an agency or its contractor may only purchase PM10-efficient street sweepers for their fleets and at least one sweeper must be placed into service by July 1, 2008. PM10-efficient street sweepers are to be used along routine street sweeper routes, which have been predetermined and prioritized by the agency as having paved curbs with the greatest actual or potential for dirt and silt loading. If an agency cannot meet these provisions due to budgetary constraints, a statement of financial hardship must be submitted to the District and the USEPA for review and approval.
- **Cleaning Paved Roads after a Storm Event:** Within 24 hours of discovery, the agency or contractor responsible for maintaining the roadway must remove the accumulated mud and dirt from the paved road or restrict vehicles from traveling over the mud and dirt until the materials can be removed. This requirement applies if the accumulated mud and dirt is a result of wind or water erosion and runoff, is at least one inch thick, and covers an area of at least 50 square feet. Cleanup may be performed manually with a shovel and broom, or with a conventional or PM10-efficient street sweeper, but must be performed in a manner that minimizes fugitive dust. Using a blowing device or a dry rotary brush or broom is prohibited. Redirecting traffic is one way to restrict vehicles from traveling over the mud and dirt. Upon agency notification, the District may approve an extension of the 24-hour cleanup requirement if restricting vehicles is deemed unsafe and removing the mud and dirt is not possible within 72 hours because crews are not available over a weekend or holiday.

Northern Region Office
4800 Enterprise Way
Modesto, CA 95356-8718
(209) 557-6400 ♦ FAX (209) 557-6475

Central Region Office
1990 East Gettysburg Avenue
Fresno, CA 93726-0244
(559) 230-6000 ♦ FAX (559) 230-6062

Southern Region Office
2700 "M" Street, Suite 275
Bakersfield, CA 93301-2373
(661) 326-6900 ♦ FAX (661) 326-6985

- **Posting Speed Limit Signs on Unpaved Roads:** Effective October 1, 2005, public agencies must establish a maximum speed limit of 25 miles per hour for the unpaved roads under their jurisdictions. This requirement applies to the unpaved road segments where vehicle traffic reaches or exceeds 26 annual average daily trips (AADT). At a minimum, agencies are to post at least one speed limit sign in each direction for every mile of unpaved road located within an urban area, and one sign in each direction for every two miles of unpaved road within a rural area. For example, an unpaved road located within an urban area that is ½ mile long and exceeds 26 AADT requires at least one sign posted in each direction. The unpaved surface must be maintained in a stabilized condition at all times in order to control fugitive emissions.
- **Paving Existing Unpaved Roads and Paving or Stabilizing Unpaved Shoulders:** On January 1, 2005, agencies provided the District with a report listing each unpaved road located within an urban area and each paved road with unpaved shoulders within urban and rural areas. On July 1, 2005, agencies provided a report listing each unpaved road located within a rural area. These reports include the length in miles and the AADT for each subject road and unpaved shoulder within the agency's jurisdiction.

As of January 1, 2005, agencies are to pave an annual average of 20 percent of the unpaved roads listed in their urban area unpaved road report, thereby paving 100 percent of these unpaved roads by January 1, 2010. This requirement does not apply to rural unpaved roads.

In urban areas, agencies are to pave or stabilize at least four-feet of unpaved shoulders on at least 50 percent of the existing paved roadways having the highest AADT. In rural areas, this is required on at least 25 percent of the existing paved roadways with the highest AADT. Compliance with these provisions must be complete by January 1, 2010.

If an agency cannot meet these provisions due to budgetary constraints, a statement of financial hardship must be submitted to the District and the USEPA for review and approval.

- **Incremental Progress Reports:** Due on April 1 of each year, from 2006 through 2010, agencies must report their incremental progress to the District by reporting the total miles of urban unpaved roads that were paved over the previous calendar year, the total miles of unpaved shoulders that were paved or stabilized over the previous calendar year, and the percentage of cumulative miles treated relative to the original reports.

For more information please contact the Compliance Department of the District office nearest to you. Information on Regulation VIII is available on the District's website at:

www.valleyair.org



COMPLIANCE ASSISTANCE BULLETIN
April 2007

Fugitive Dust Control at Construction Sites: New Requirements

Regulation VIII, Fugitive PM10 Prohibitions, of the District's Rules and Regulations apply to many activities that generate fugitive dust, and particularly to construction sites.

Fugitive dust is emitted into the air by activities that disturb the soil, such as earthmoving and vehicular/equipment traffic on unpaved surfaces. Windblown dust is also of concern where soil has been disturbed at construction sites.

The District adopted Regulation VIII in 1993 and its most recent amendments became effective on October 1, 2004. This is a basic summary of the regulation's requirements as they apply to construction sites.

These regulations affect all workers at a regulated construction site, including everyone from the landowner to the subcontractors. Violations of Regulation VIII are subject to enforcement action including fines.

Visible Dust Emissions (VDE) may not exceed 20% opacity during periods when soil is being disturbed by equipment or by wind at any time. Visible Dust Emissions opacity of 20% means dust that would obstruct an observer's view of an object by 20%. District inspectors are state certified to evaluate visible emissions. Dust control may be achieved by applying water before/during earthwork and onto unpaved traffic areas, phasing work to limit dust, and setting up wind fences to limit wind blown dust.

Soil Stabilization is required at regulated construction sites after normal working hours and on weekends and holidays. This requirement also applies to inactive construction areas such as phased projects where disturbed land is left unattended. Applying water to form a visible crust on the soil and restricting vehicle access are often effective for short-term stabilization of disturbed surface areas. Long-term methods including applying dust suppressants and establishing vegetative cover.

Carryout and Trackout occur when materials from emptied or loaded vehicles falls onto a paved surface or shoulder of a public road or when materials adhere to vehicle tires and are deposited onto a paved surface or shoulder of a public road. Should either occur, the material must be cleaned up at least daily, and immediately if it extends more than 50 feet from the exit point onto a paved road. The appropriate clean-up methods require the complete removal and cleanup of mud and dirt from the paved surface and shoulder. Using a blower device or dry sweeping with any mechanical device other than a PM10-efficient street sweeper is a violation. Larger construction sites, or sites with a high amount of traffic on one or more days, must prevent carryout and trackout from occurring by installing gravel pads, grizzlies, wheel washers, paved interior roads, or a combination thereof at each exit point from the site. In many cases, cleaning up trackout with water is also prohibited as it may lead to plugged storm drains. Prevention is the best method.

Unpaved Access and Haul Roads, as well as unpaved vehicle and equipment traffic areas at construction sites must have dust control. Speed limit signs limiting vehicle speed to 15 mph or less at construction sites must be posted every 500 feet on uncontrolled and unpaved roads.

Northern Region Office
4800 Enterprise Way
Modesto, CA 95356-8718
(209) 557-6400 ♦ FAX (209) 557-6475

Central Region Office
1990 East Gettysburg Avenue
Fresno, CA 93726-0244
(559) 230-6000 ♦ FAX (559) 230-6062

Southern Region Office
2700 "M" Street, Suite 275
Bakersfield, CA 93301-2373
(661) 326-6900 ♦ FAX (661) 326-6985

Storage Piles and Bulk Materials have handling, storage, and transportation requirements that include applying water when handling materials, wetting or covering stored materials, and installing wind barriers to limit VDE. Also, limiting vehicle speeds, loading haul trucks with a freeboard of six inches or greater along with applying water to the top of the load, and covering the cargo compartments are effective measures for reducing VDE and carryout from vehicles transporting bulk materials.

Demolition activities require the application of water to the exterior of the buildings and to unpaved surfaces where materials may fall. A Dust Control Plan will be required for large demolition projects. Consider all structures slated for demolition as possibly being regulated due to potential asbestos, per District Rule 4002 - *National Emission Standards for Hazardous Air Pollutants*. Contact the District well before starting because a 10 working-day notice will likely be required before a demolition can begin.

Dust Control Plans identify the dust sources and describe the dust control measures that will be implemented before, during, and after any dust generating activity for the duration of the project. Owners or operators are required to submit plans to the District at least 30 days prior to commencing the work for the following:

- Residential developments of ten or more acres of disturbed surface area.
- Non-residential developments of five or more acres of disturbed surface area.
- The relocation of more than 2,500 cubic yards per day of materials on at least three days.

Operations may not commence until the District has approved the Dust Control Plan. A copy of the plan must be on site and available to workers and District employees. **All work on the site is subject to the requirements of the approved dust control plan. A failure to abide by the plan by anyone on site may be subject to enforcement action.**

Owners or operators of construction projects that are at least one acre in size and where a Dust Control Plan is not required, must provide written notification to the District at least 48 hours in advance of any earthmoving activity.

Record Keeping is required to document compliance with the rules and must be kept for each day any dust control measure is used. The District has developed record forms for water application, street sweeping, and “permanent” controls such as applying long term dust palliatives, vegetation, ground cover materials, paving, or other durable materials. Records must be kept for one year after the end of dust generating activities (Title V sources must keep records for five years).

Exemptions exist for several activities. Those occurring above 3,000 feet in elevation are exempt from all Regulation VIII requirements. Further, Rule 8021 – *Construction, Demolition, Excavation, Extraction, and Other Earthmoving Activities* exempts the following construction and earthmoving activities:

- Blasting activities permitted by California Division of Industrial Safety.
- Maintenance or remodeling of existing buildings provided the addition is less than 50% of the size of the existing building or less than 10,000 square feet (due to asbestos concerns, contact the District at least two weeks ahead of time).
- Additions to single family dwellings.
- The disking of weeds and vegetation for fire prevention on sites smaller than ½ acre.
- Spreading of daily landfill cover to preserve public health and safety and to comply with California Integrated Waste Management Board requirements.

Nuisances are prohibited at all times because District Rule 4102 – *Nuisance* applies to all construction sources of fugitive dust, whether or not they are exempt from Regulation VIII. It is important to monitor dust-generating activities and implement appropriate dust control measures to limit the public's exposure to fugitive dust.

For more information please contact the Compliance Division of the District office nearest to you. Information on Regulation VIII, where you may obtain copies of record keeping forms, the Dust Control Plan template, and the Construction Notification form, is available on the District's website at:

www.valleyair.org, under Compliance Assistance/Dust Control.